



**THE
PREVENTIVE
MAINTENANCE
MONTHLY**

ISSUE 790 SEPTEMBER 2018



COMBAT VEHICLES 2

Stryker, Engine Hatch Gas Spring Replacement 3-4
 VV-Hull Stryker, No Jumping through Hatch 4-5
 M1129E1, M1252 MC Strykers, Mortar Tube PM Stryker Cargo Net NSNs 6
 M777A2, M119A2/A3 Towed Howitzers, Cradle Crack Inspection 7
 M2A3/M3A3 Bradley, Periscope Thumbscrew Rust 8



TACTICAL VEHICLES 10

Rust Busters Tip of the Month 11-13
 HMMWV Delaminated Windshield Info 14-15



CONSTRUCTION 16

M1272 Buffalo PM Tips 17-20
 Minehound Operation, PM Tips 41-43



AVIATION 21

H-60L/M, Rescue Hoists Require Inspections 22-23
 New Apache Flyer's Helmet TM Available 23
 T700 Engine Manual Only in IETM 23
 AH-64D/E, Don't Use Unauthorized Tool 24-25
 Shadow Support POC 25
 TB 43-180 Released 25
 Army Aviation Combat Uniform OCP 26
 Flight Suit NSNs 26



SMALL ARMS 35

M16-Series Rifle, M4/M4A1 Carbine Cleaning Tools 36-37
 M249 AAL Additions 38
 M320/M320A1 Grenade Launcher, Latch Buttstock Locking Lever 39
 M120A1 Mortar, Breech Cap Installation 40
 RCO, ACOG Sights Turn-in Update 40



CBRN 44

M50 Protective Mask PM Tips 44-45



MISSILES 45

HIMARS Cab Latch Cracks 45



COMMUNICATIONS 46

AN/PVS-14, AN/PVS-7B/D NVD PM Tips 47-49
 TC 6-02.20 Cable and Wire Handbook Available 49
 MEP-804B Alternator NSN 49
 AN/PSQ-39 Operator's TM Released 49
 KG-250 Battery and ISSP Guidance 50-51
 AN/VVS-2 Parts Needed for Turn-in 51
 TK-101/G Electronic Equipment Tool Kit Components 52-56



LOGISTICS MANAGEMENT 57

Truck B-Kit Accountability 58-59
 Where to Find Special Packaging Instructions 60

Dax Torthon in the 26th Century 27-34

Connie's Post Scripts 61

TB 43-PS-790, *The Preventive Maintenance Monthly*, is an official publication of the Department of the Army, providing information for all Soldiers assigned to combat and combat support units and all Soldiers with unit maintenance and supply duties. All information published has been reviewed and approved by the authority responsible for the equipment, publication or policy discussed. Application of the information is optional with the user. Masculine pronouns may refer to both genders. The use of product or company names does not constitute endorsement of those products, services or companies by the U.S. Army. The use of non-DoD hyperlinks, along with their content, does not constitute endorsement by DoD or DA. Neither DoD nor DA exercises any editorial control over, and cannot vouch for, content on non-DoD websites.

PS, The Preventive Maintenance Monthly (ISSN 0475-2953)
 is published monthly by the Department of the Army, Redstone Arsenal, AL 35898.

You are invited to send PS your ideas for improving maintenance procedures, questions on maintenance and supply problems and questions or comments on material published in PS.

Just write to:

MSG Half-Mast
PS, the Preventive Maintenance Monthly
USAMC LOGSA (AMXLS-GP)
Bldg. 3303
Redstone Arsenal, AL 35898

Or email:

usarmy.redstone.logsa.mbx.psmag@mail.mil

Internet address:

https://www.logsa.army.mil/psmag/pshome.cfm

By Order of the Secretary of the Army:

MARK A. MILLEY
 General, United States Army
 Chief of Staff

Official:

MARK F. AVERILL
 Acting Administrative Assistant
 to the Secretary of the Army
 1816258

Issue 790

PS

September
2018

THE PREVENTIVE MAINTENANCE MONTHLY

TB 43-PS-790

Approved for
Public Release;
Distribution is
Unlimited

TIME TO GET
OFF YOUR TABLET
AND GET ON THE
EQUIPMENT!

TIME TO
KNOW WHAT
TO DO *BEFORE*
GETTING
STARTED.



COMBAT VEHICLES 2

- Stryker, Engine Hatch Gas Spring Replacement 3-4
- VV-Hull Stryker, No Jumping through Hatch 4-5
- M1129E1, M1252 MC Strykers, Mortar Tube PM Stryker Cargo Net NSNs 6
- M777A2, M119A2/A3 Towed Howitzers, Cradle Crack Inspection 8
- M2A3/M3A3 Bradley, Periscope Thumbscrew Rust 9

TACTICAL VEHICLES 10

- Rust Busters Tip of the Month 11-13
- HMMWV Delaminated Windshield Info 14-15

CONSTRUCTION 16

- M1272 Buffalo PM Tips 17-20
- Minehound Operation, PM Tips 41-43

AVIATION 21

- H-60L/M, Rescue Hoists Require Inspections 22-23
- New Apache Flyer's Helmet TM Available 23
- T700 Engine Manual Only in IETM 23
- AH-64D/E, Don't Use Unauthorized Tool Shadow Support POC 24-25
- TB 43-180 Released 25
- Army Aviation Combat Uniform OCP Flight Suit NSNs 26

Dax Torthon in the 26th Century 27-34

SMALL ARMS 35

- M16-Series Rifle, M4/M4A1 Carbine Cleaning Tools 36-37
- M249 AAL Additions 38
- M320/M320A1 Grenade Launcher, Latch Buttstock Locking Lever 39
- M120A1 Mortar, Breech Cap Installation 40
- RCO, ACOG Sights Turn-in Update 40

CBRN 44

- M50 Protective Mask PM Tips 44-45

MISSILES 45

- HIMARS Cab Latch Cracks 45

COMMUNICATIONS 46

- AN/PVS-14, AN/PVS-7B/D NVD PM Tips 47-49
- TC 6-02.20 Cable and Wire Handbook Available MEP-804B Alternator NSN 49
- AN/PSQ-39 Operator's TM Released 49
- KG-250 Battery and ISSP Guidance 50-51
- AN/VVS-2 Parts Needed for Turn-in TK-101/G Electronic Equipment Tool Kit Components 51

LOGISTICS MANAGEMENT 57

- Truck B-Kit Accountability 58-59
- Where to Find Special Packaging Instructions 60

Connie's Post Scripts 61

TB 43-PS-790, The Preventive Maintenance Monthly, is an official publication of the Department of the Army, providing information for all Soldiers assigned to combat and combat support units and all Soldiers with unit maintenance and supply duties. All information published has been reviewed and approved by the agency responsible for the equipment, publication or policy discussed. Application of the information is optional with the user. Masculine pronouns may refer to both genders. The use of product or company names does not constitute endorsement of those products, services or companies by the U.S. Army. The use of non-DoD hyperlinks, along with their content, does not constitute endorsement of DoD or DA. Neither DoD nor DA exercises any editorial control over, and cannot vouch for, content on non-DoD websites.

PS, The Preventive Maintenance Monthly (ISSN 0475-2953) is published monthly by the Department of the Army, Redstone Arsenal, AL 35898.

You are invited to send PS your ideas for improving maintenance procedures, questions on maintenance and supply problems and questions or comments on material published in PS.

Just write to:
MSG Half-Mast
PS, the Preventive Maintenance Monthly
USAMC LOGSA (AMXLS-GP)
 Bldg. 3303
 Redstone Arsenal, AL 35898

Or email:
usarmy.redstone.logsa.mbx.psmag@mail.mil

Internet address:
https://www.logsa.army.mil/psmag/pshome.cfm

By Order of the Secretary of the Army:

MARK A. MILLEY
 General, United States Army
 Chief of Staff

Official:

MARK F. AVERILL
 Acting Administrative Assistant
 to the Secretary of the Army
 181625B

BULK UP THAT BRAIN!



WE HAVE THE WORLD'S BEST EQUIPMENT -- AND NOW I KNOW HOW TO TAKE CARE OF IT!



FACT:

THE BRAIN HAS A LOT IN COMMON WITH BODY MUSCLE. WHEN IT **DOESN'T** GET USED, IT GETS **WEAKER!**



GO READ A BOOK FOR CRYIN' OUT LOUD!

FOR YEARS, THE ARMY'S PREVENTIVE MAINTENANCE CHECKS AND SERVICES (PMCS) FELL SQUARELY ON **UNIFORMED** SHOULDERS.



WHEN IT WAS DONE DAY IN AND DAY OUT (AND BY THE TMS), PMCS BECAME A **GOOD HABIT**. BUT...

...DURING RECENT YEARS, MANY MAINTENANCE TASKS **SHIFTED** TO CONTRACTORS, FREEING UP SOLDIERS TO DEPLOY AND FIGHT.

THE PRICE WAS A **COSTLY LOSS** IN KNOWLEDGE; NOT JUST ABOUT **PS MAGAZINE**, BUT ALL THE **IMPORTANT STUFF** WE COVER, COVER TO COVER.

NOW THINGS HAVE COME FULL CIRCLE.

THE ARMY IS LOOKING TO ITS RANKS AGAIN AND EXPECTING **PMCS STATS TO SOAR.**

PS IS YOUR MAINTENANCE MENTOR, YOUR COACH FOR EQUIPMENT CARE AND WE'RE HERE TO PUMP UP YOUR BRAIN AGAIN.



FOLLOW THE MAP TO OUR FREE APP AND THE RIGHT PATH TO PMCS AT:
<https://www.logsa.army.mil/psmag/pshome.cfm>

- Avoid Engine Hatch Spring Surprise
- Don't Jump to It!
- Mortar Tube Maintenance Info
- Keep It Secure with Cargo Nets!
- Watch Out For Cradle Cracks
- Thumb Nose at Thumbscrew Rust

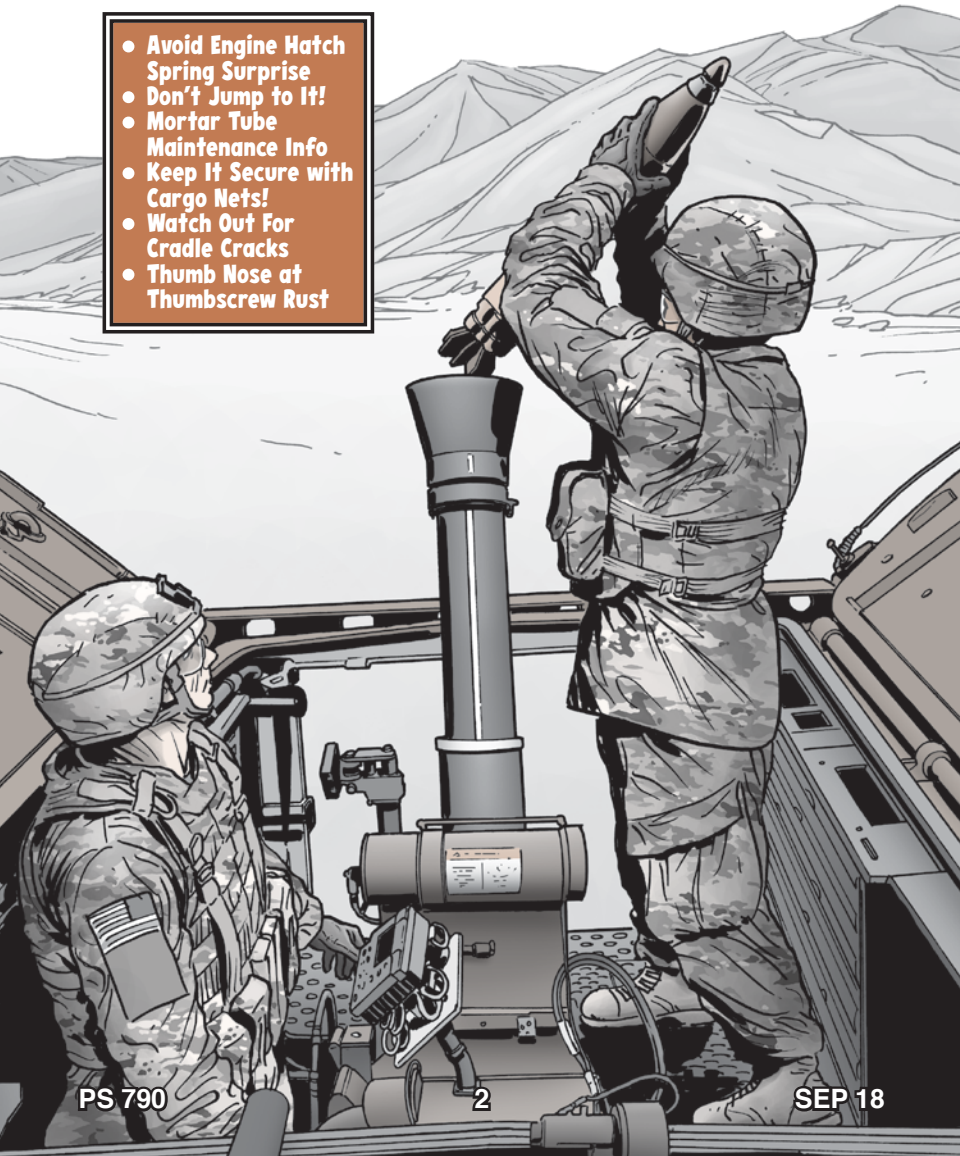

Stryker...

AVOID ENGINE HATCH SPRING SURPRISE

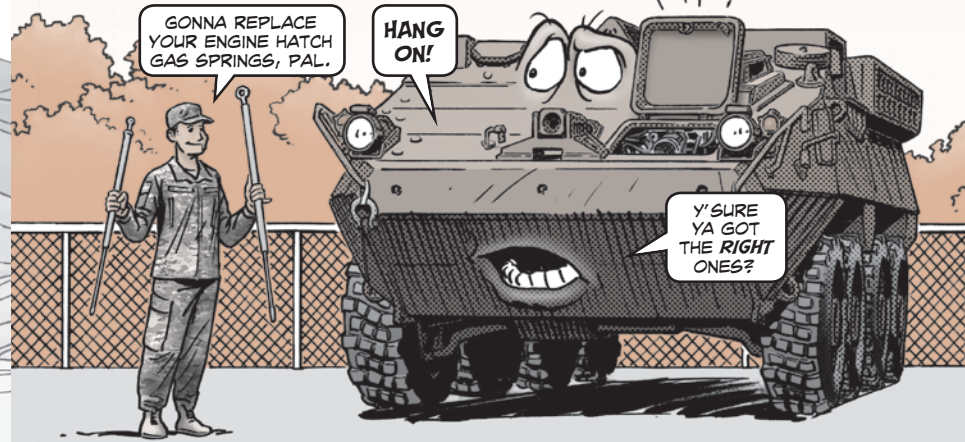

MECHANICS, WHEN IT'S TIME TO REPLACE THE STRYKER'S ENGINE HATCH GAS SPRINGS, MAKE SURE YOU'RE USING THE RIGHT ONES!

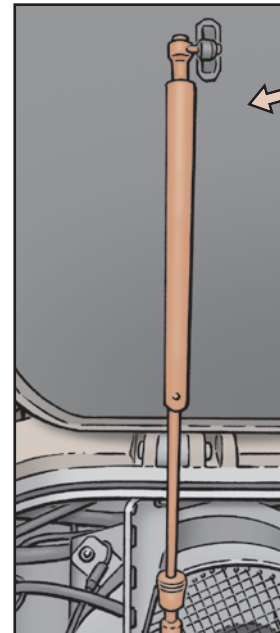

TWO DIFFERENT GAS SPRINGS CAN COME WITH NSN 3040-01-601-1055, BUT ONLY ONE IS THE RIGHT ONE.

LUCKILY, THEY'RE EASY TO TELL APART.



YOU'LL KNOW YOU HAVE THE RIGHT GAS SPRING IF IT'S MARKED WITH PART NUMBER C16-28949.

THE **WRONG** GAS SPRING HAS A SOLID SILVER TIP ON **BOTH** ENDS...

...AND IS FOUR-AND-A-HALF INCHES LONGER THAN THE **RIGHT** ONE.



IT'S **ALSO** MARKED WITH PART NUMBER C16-26949.

WWW.SUSPAPARTS.COM
DO NOT OPEN-HIGH PRESSURE
SUSPA
C16-26949
MADE IN U.S.A.
17/38

Check part number to ensure you have correct gas spring

IF YOU INSTALL THE **WRONG** GAS SPRING, THE GAS CYLINDER AND LOWER MOUNTING BRACKET, NSN 5340-21-921-3610, ARE **DAMAGED**.

EVEN WORSE, THE **WRONG** GAS SPRING **CAN'T** SUPPORT AS MUCH WEIGHT, SO THE ENGINE HATCH **COULD** FALL AND **HURT** SOMEONE!

UNITS RECEIVING THE **WRONG** GAS SPRING CAN SUBMIT A SUPPLY DISCREPANCY REPORT (SDR) THROUGH THE PRODUCT DATA REPORTING AND EVALUATION PROGRAM (PDREP) AT:
<https://www.pdrep.csd.disa.mil/>

PS END

Double V-Hull Stryker...

READY OR NOT, HERE I COME!

DON'T JUMP TO IT!

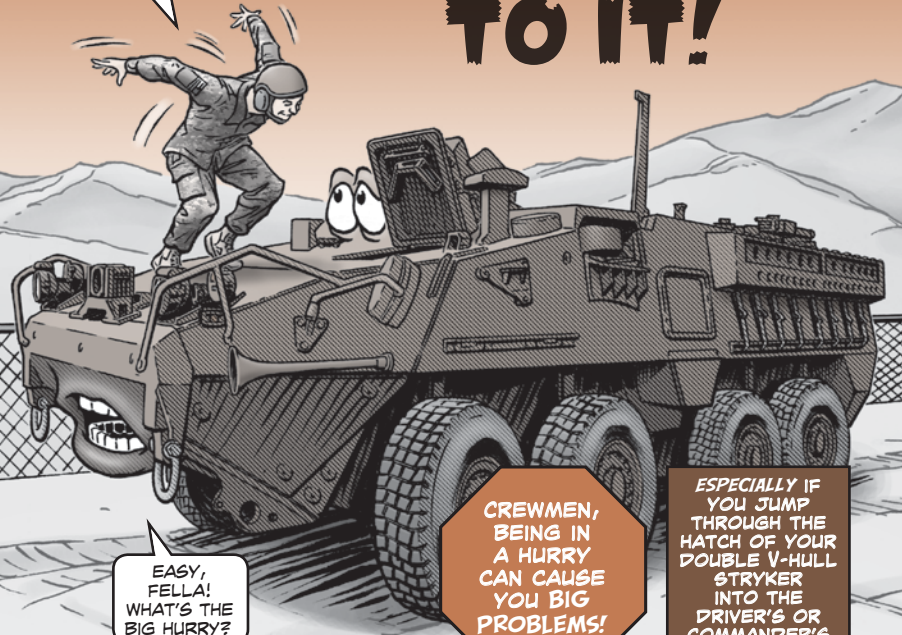

EASY, FELLA! WHAT'S THE BIG HURRY?

CREWMEN, BEING IN A HURRY CAN CAUSE YOU BIG PROBLEMS!

ESPECIALLY IF YOU JUMP THROUGH THE HATCH OF YOUR DOUBLE V-HULL STRYKER INTO THE DRIVER'S OR COMMANDER'S SEAT.

Don't jump through commander's or driver's hatch...

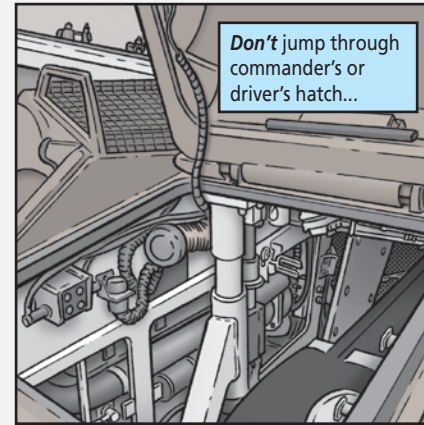

THE FORCE FROM JUMPING CAN **SNAP** THE SHEAR PIN ON THE ENERGY ATTENUATING (EA) SEATS.

THE SHEAR PIN REPLACEMENT KIT, NSN 5308-20-008-6803, IS A CRITICAL PART OF THE EA SEAT THAT HELPS TO PROTECT YOU DURING A BLAST.

A DAMAGED PIN MEANS THE SEAT **CAN'T** KEEP YOU SAFE IF YOUR VEHICLE HITS A MINE OR IED.

DRIVERS AND VEHICLE COMMANDERS, BE SURE TO **EASE** THROUGH THE HATCH ONTO YOUR SEAT, BEING CAREFUL **NOT** TO PLACE ALL YOUR WEIGHT ON THE SEAT AT ONCE.

...onto energy attenuating (EA) seat...

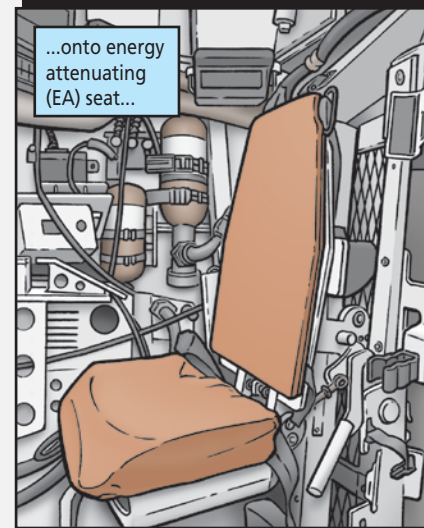

BE **REALLY** CAREFUL IF YOU'RE WEARING FULL COMBAT GEAR. THAT'LL HELP PROTECT THOSE SHEAR PINS FROM BREAKING.



ALSO, **DON'T** REPLACE A BROKEN SHEAR PIN WITH A STANDARD BOLT. THE EA SEAT **WON'T** WORK RIGHT WITH A STANDARD BOLT AND THAT'LL MAKE YOUR STRYKER NMC!

...or shear pin can snap

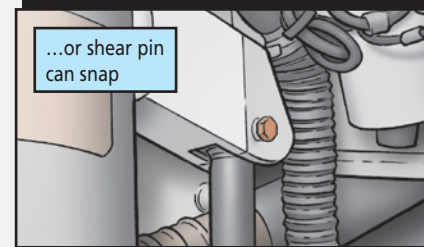

SHEAR PINS HAVE A **BRIGHT RED BOLT HEAD**.

TAKE A LOOK AT THE SHEAR PINS ON YOUR VEHICLE'S DRIVER AND COMMANDER SEATS. IF THE BOLT HEAD **ISN'T** BRIGHT RED, ASK YOUR MECHANIC TO MAKE SURE THAT A SHEAR PIN IS INSTALLED.

MORTAR TUBE MAINTENANCE INFO

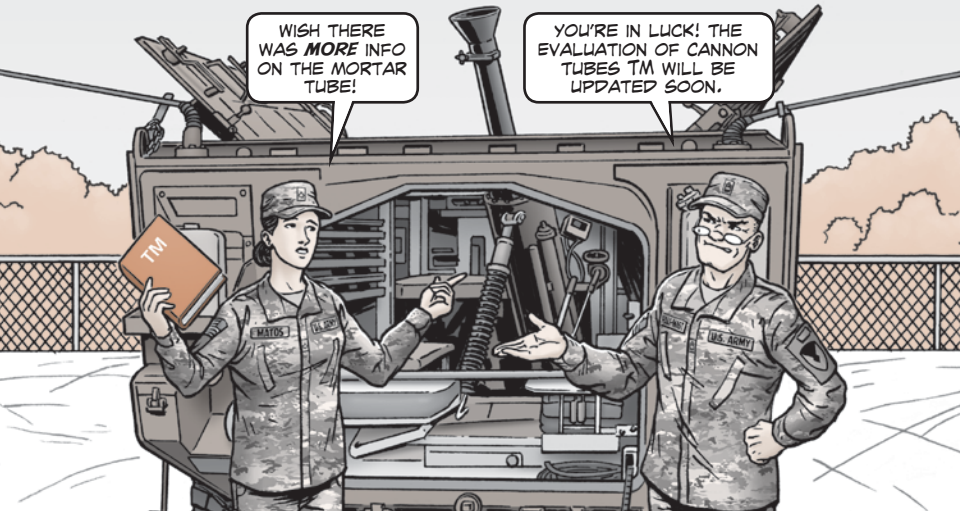

When it comes to maintaining cannon tubes, the best info source out there is TM 9-1000-202-14, *Evaluation of Cannon Tubes*. But unfortunately it doesn't include anything on the Stryker's unique recoilless mortar system (RMS6-L) 120mm mortar tube.

Don't fret, though. That's changing. The next TM revision will have plenty of information on operator and field-level inspection criteria and sustainment-level maintenance for that tube. The revision is slated for later this year.

In the meantime, you can find a link to the complete maintenance and inspection appendix that's being added to the TM by checking out TACOM Maintenance Action Message 18-006:

<https://tulsa.tacom.army.mil/Maintenance/message.cfm?id=MA18-006.html>

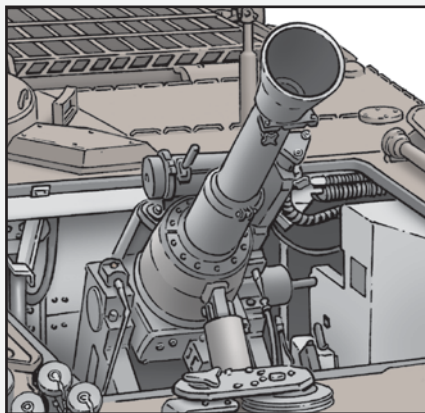

Info on Stryker's 120mm mortar tube will be added to TM 9-1000-202-14

Stryker...

KEEP IT SECURE WITH CARGO NETS!

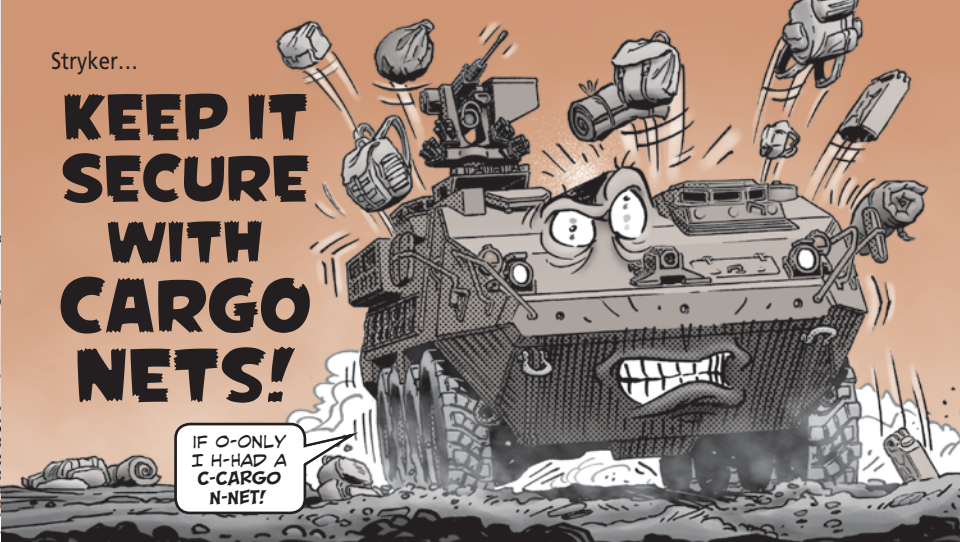

CREWMEN, CARGO NETS COMES IN REAL HANDY FOR YOUR STRYKER. THEY ENSURE ALL THE GEAR AND EQUIPMENT ON THE OUTSIDE OF YOUR VEHICLE STAY STRAPPED DOWN TIGHT. NO MATTER WHERE THE MISSION TAKES YOU.



THE NETS FIT ALL STRYKER VARIANTS, INCLUDING THE DOUBLE V-HULL STRYKER.

Item	NSN
Side net	2541-01-666-1273
Top net	2541-01-666-1271
Rope lock	4030-01-666-1262
Footman loop	5342-01-666-1278
Quick tie down	2541-01-666-4544
Camless strap	5340-01-666-1322
Existing bolt attachment bracket (EBAB)	2590-01-666-4602
Ammo harness	2541-01-666-1489

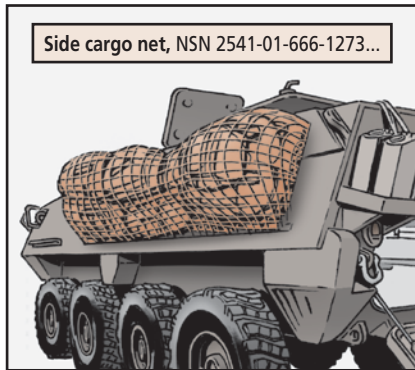

Side cargo net, NSN 2541-01-666-1273...

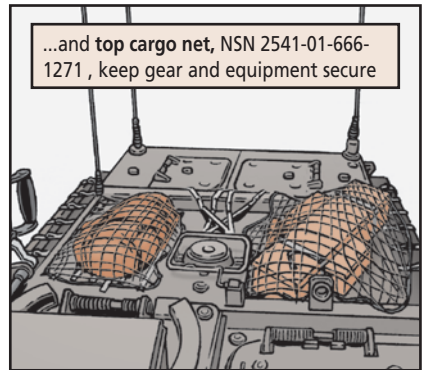

...and top cargo net, NSN 2541-01-666-1271, keep gear and equipment secure

WATCH OUT FOR CRADLE CRACKS

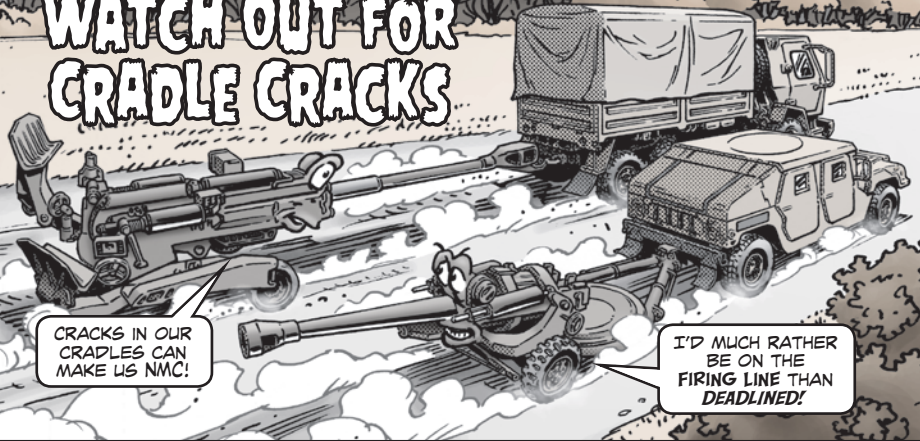

CRACKS IN OUR CRADLES CAN MAKE US NMC!

I'D MUCH RATHER BE ON THE FIRING LINE THAN DEADLINED!

CREW MEN, YOUR M119A2/A3 AND M777A2 TOWED HOWITZERS CAN DEVELOP CRACKS IN THE CRADLE STRUCTURE. IF THAT HAPPENS, YOUR FIRE MISSIONS WON'T BE EVERYTHING THEY'RE CRACKED UP TO BE!

IF YOUR M777A2 HAS WELDED PURGE PORTS, CRACKS CAN APPEAR ON THE TOP OF THE TRAVEL LOCK AND AXLE HOUSING. ANY CRACK THAT'S **FOUR INCHES OR MORE** FROM EITHER SIDE OF THE PURGE PORTS MAKES THE GUN NMC.

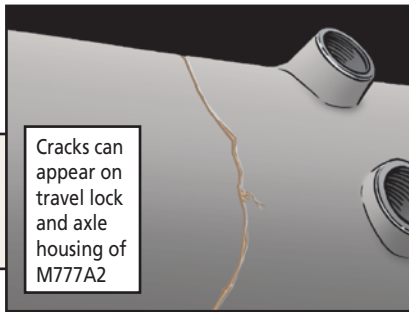

Cracks can appear on travel lock and axle housing of M777A2

THE M119A2/A3 HOWITZERS CAN DEVELOP CRACKS IN THE WELD BETWEEN THE ELEVATION BLOCK AND THE MAIN CRADLE.

INSPECT ALL M119A2/A3 HOWITZERS RIGHT AWAY FOR CRACKS IN THAT AREA!

FIND OUT HOW TO INSPECT FOR CRACKS AND A LOT MORE INFO BY CHECKING OUT TACOM MAINTENANCE INFORMATION MESSAGE 18-004 AT: <https://tulsa.tacom.army.mil/Maintenance/message.cfm?id=MA18-004.html>

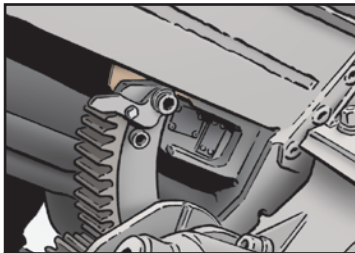

Inspect M119A2/A3 for cracks between elevation block and main cradle

YOU'LL FIND INSPECTION PROCEDURES, PMCS CHANGES TO THE OPERATOR AND MAINTENANCE MANUALS, NMC CRITERIA AND INSPECTION FORMS BY GOING TO TACOM MAINTENANCE ACTION MESSAGE 18-008 AT:

<https://tulsa.tacom.army.mil/Maintenance/message.cfm?id=MA18-008.html>

THUMB NOSE AT THUMBSCREW RUST

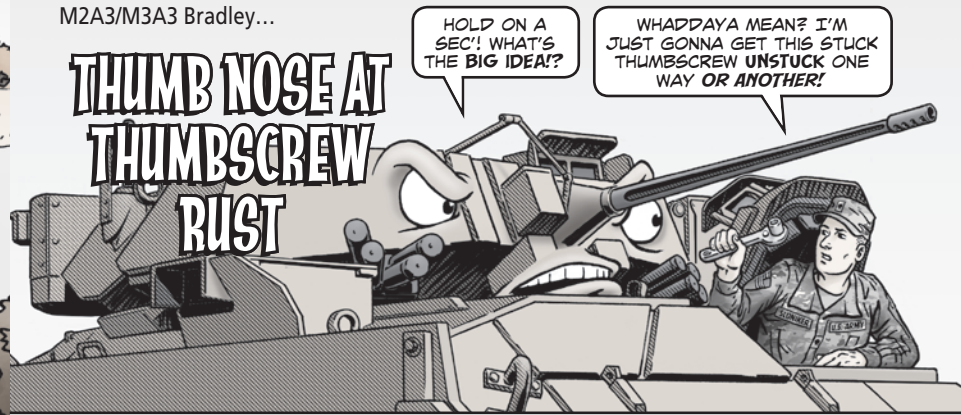

HOLD ON A SEC! WHAT'S THE BIG IDEA?

WHADDAYA MEAN? I'M JUST GONNA GET THIS STUCK THUMBSCREW UNSTUCK ONE WAY OR ANOTHER!

LATER...

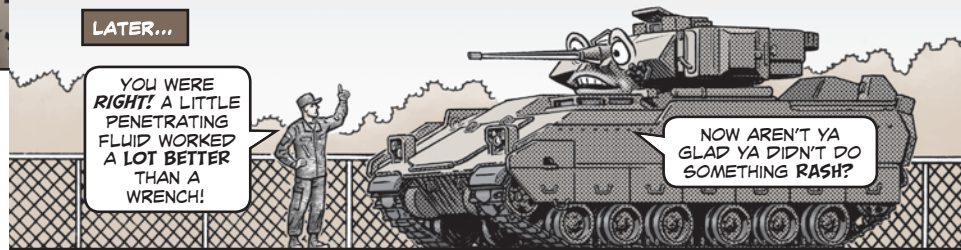

YOU WERE RIGHT! A LITTLE PENETRATING FLUID WORKED A LOT BETTER THAN A WRENCH!

NOW AREN'T YA GLAD YA DIDN'T DO SOMETHING RASH?

Crewmen, those driver's hatch periscope thumbscrews sure do come in handy when removing the periscope to install the night sight.

But rainwater and condensation can cause them to rust. Then they won't move. And they snap off if you use a wrench to try to unscrew 'em.

Then your mechanic has to drill them out before new thumbscrews can be installed. And guess what? That's right. The new ones end up getting stuck, too.

Unstuck stuck thumbscrews by spraying them with some penetrating fluid before trying to loosen them. NSN 6850-00-973-9091 brings a case of 12 10-oz spray cans. Once you've got the rusty thumbscrews out, get replacements with NSN 5305-01-106-7961.

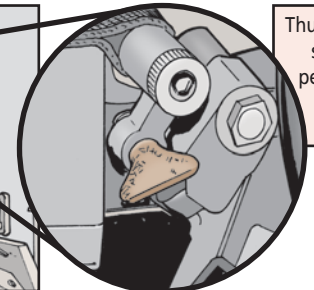
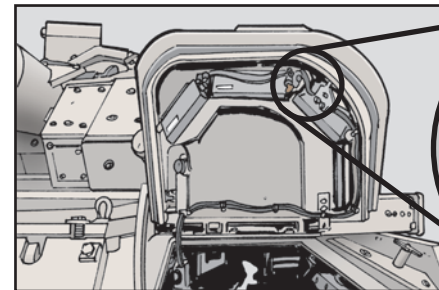

Thumbscrews stuck? Use penetrating fluid to loosen

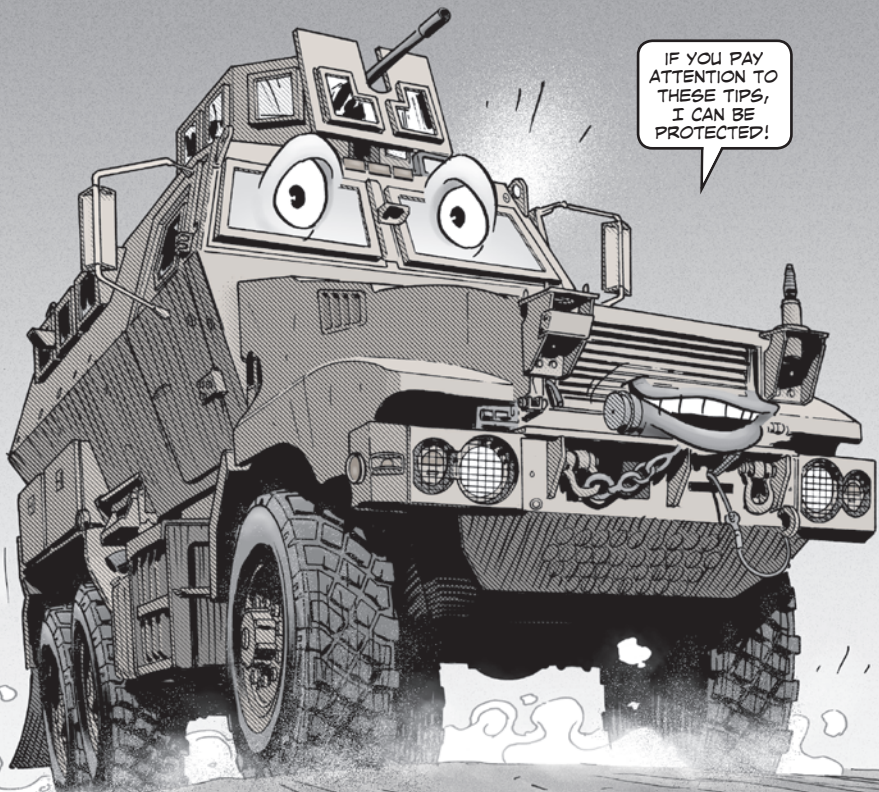

IF YOU PAY ATTENTION TO THESE TIPS, I CAN BE PROTECTED!

- Rust Busters Tip of the Month
- Delaminated Windshields: More Q & A

Corrosion...

RUST BUSTERS

TIP OF THE MONTH

BARE METAL CORRODES FAST, RESULTING IN COSTLY REPAIRS AND REDUCED READINESS.

Initial coating damage (brown spots)

Delaminated coating due to corrosion undercutting (grey region)

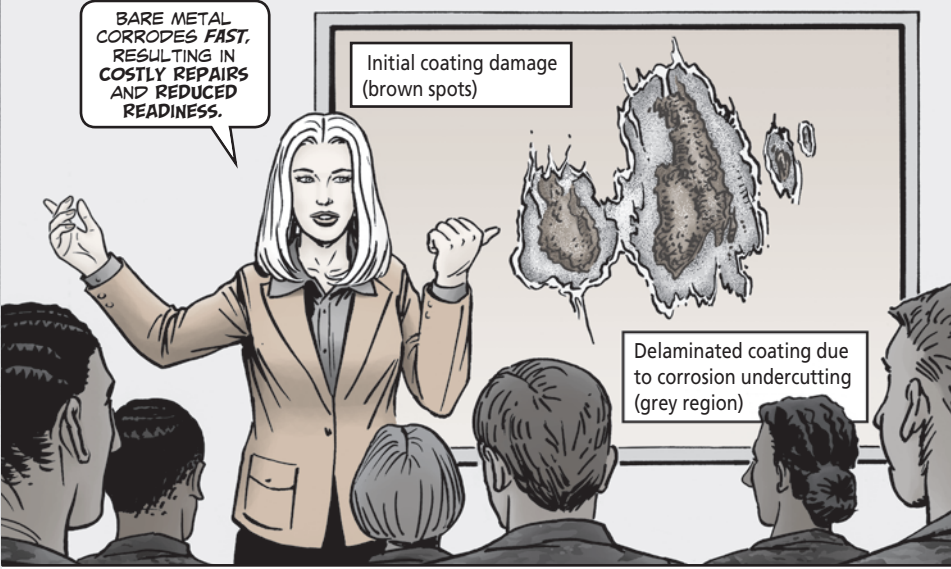

BARE METAL SPOTS... UGLY RUST PATCHES... FLAKING PAINT.

THESE ARE THE TELLTALE SIGNS OF *POTENTIAL CORROSION PROBLEMS* THAT CALL FOR PROPER SURFACE PREPARATION AND SPOT PAINTING.

SMALL SPOTS OF BARE OR RUSTY METAL NEED FIELD-LEVEL ATTENTION TO PREVENT A LARGER AND MORE COSTLY CORROSION PROBLEM.

BUT THE *SUCCESS* OF SPOT PAINTING DEPENDS ON SURFACE PREPARATION, WHICH HINGES ON TWO CRITICAL PREP STEPS:

- 1) CLEANING AND
- 2) ROUGHENING.

FORTUNATELY, THESE TROUBLE SPOTS CAN GENERALLY BE CURED WITH SPOT PAINTING.



Prep Step #1: Cleaning

BEFORE SPOT PAINTING, SURFACE CLEANING **MUST** BE DONE TO REMOVE DIRT AND GRIME.

IF THE SURFACE **ISN'T** CLEAN, PAINT **WON'T** APPLY EVENLY.

IF YOU SEE GRAINY BUMPS OR STREAKS DURING PAINTING OR AS THE PAINT DRIES, IT'S A SIGN THAT THE SURFACE **WASN'T** CLEAN.

THE NEW PAINT WILL LIKELY PEEL OR FLAKE, WASTING YOUR EFFORT AND RESOURCES.

SO DO IT RIGHT THE FIRST TIME!

If surface *isn't* clean, paint won't stick



CHOOSE ABRASIVE MATERIALS AND THEIR DEGREE OF GRIT BASED ON THE TYPE OF METAL UNDERLYING THE BARE OR RUST SPOT.

FOR EXAMPLE, 80 TO 100 GRIT ABRASIVE CLOTH IS BEST FOR REMOVING RUST OR CLEANING AND POLISHING IRON AND STEEL SURFACES.

HOWEVER, DON'T USE ANYTHING MORE ABRASIVE THAN 100 GRIT ON CLOSE TOLERANCE PARTS BECAUSE IT COULD CAUSE DAMAGE.

POWER TOOLS, LIKE AUTOMATIC SANDERS, OR HAND CLEANING WITH ABRASIVE PAPER AND WIRE BRUSHES ARE ACCEPTABLE ABRASIVES. IF YOU USE POWER TOOLS, HOWEVER, MAKE SURE YOU WEAR **PROPER PROTECTIVE GEAR** AND **FOLLOW ENVIRONMENTALLY COMPLIANT METHODS** TO POWER GRIND SURFACES USING A HEPA VACUUM.

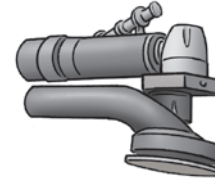

Use automatic sander, wire brush or sand paper to roughen surfaces



CLEAN THE SURFACE OF ANY: DIRT, SALT, LUBES, AND CONTAMINANTS.



CAN YOU NAME THE **FOUR BEST METHODS** FOR PROPER SURFACE CLEANING?

DETERGENTS!
SOLVENTS!
ALKALINE CLEANERS!
STEAM CLEANING!

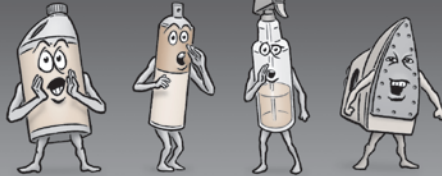

NOTE:

IT MIGHT TAKE **MORE THAN ONE** OF THESE METHODS TO **FULLY** CLEAN THE SURFACE, DEPENDING ON HOW DIRTY IT IS.

RINSE THE AREA WELL AFTERWARDS AND LET IT DRY **COMPLETELY**.

Prep Step #2: Roughening

AFTER A THOROUGH CLEANING, THE SURFACE **MUST** BE **ROUGHENED** WITH AN ABRASIVE MATERIAL.



Be Aware!

IF YOU SKIP OR SKIMP ON THIS IMPORTANT STEP, THE PAINT **WON'T** STICK AND ONCE AGAIN, YOUR EFFORTS WILL BE **WASTED!**

SAND THE AREA AND FEATHER THE EDGES TO PROVIDE A SMOOTH TRANSITION FROM OLD COATING TO BASE METAL. LIGHTLY SAND THE SURROUNDING INTACT PAINT WITH A FINE GRIT ABRASIVE CLOTH (200 GRIT OR HIGHER) TO SLIGHTLY ROUGHEN IT WITHOUT REMOVING ANY PAINT.

Taper old paint and primer edges down to bare metal

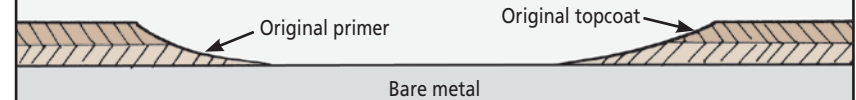

WITHIN **FOUR HOURS** OF SANDING, WIPE THE SURFACE WITH CLEANING SOLVENT.

LET THE AREA DRY COMPLETELY AFTER THIS FINAL CLEANING, THEN APPLY A PRETREATMENT (TYPICALLY A PRIMER COAT).



DO THIS **ASAP** TO **PREVENT** THE FRESHLY SANDED METAL FROM RUSTING.

ONCE THE PRIMER CURES, YOU'RE **READY TO PAINT!**

COMING NEXT MONTH IN PS MAGAZINE: SPOT PAINTING TIPS!

Additional Resources

FOR PRETREATING FERROUS SURFACES, FOLLOW TT-C-490F. FOR ALUMINUM, USE MIL-DTL-5541F.

MORE GUIDANCE ON SURFACE PREP AND SPOT PAINTING IS ALSO AVAILABLE IN TB 43-0213, WP 0032 & 0033, CORROSION PREVENTION AND CONTROL (CPAC) FOR ARMY WHEELED VEHICLES (SEP 12).

GET IT FROM LOGSA AT: <https://liw.logsa.army.mil/etmapp/#/etm/home>

DELAMINATED WINDSHIELDS:

HERE AT PS MAGAZINE, WE RECEIVE A LOT OF QUESTIONS ABOUT DELAMINATED HMMWV WINDSHIELDS. QUESTIONS LIKE...

MORE Q & A

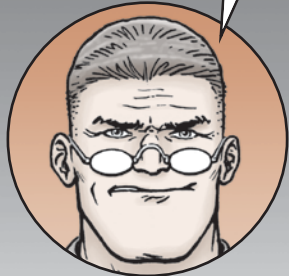

CAN YOU PREVENT DELAMINATION DAMAGE?

SEE PS 639-60.

WHAT DAMAGE QUALIFIES FOR REPLACEMENT?

SEE PS 762-11.

WHEN IS IT **BAD ENOUGH** TO BE NMC?

SEE PS 736-6-7.

WHAT'S THE NSN FOR REPLACEMENTS?

SEE PS 760-18-19, 725-60 AND 722-17.

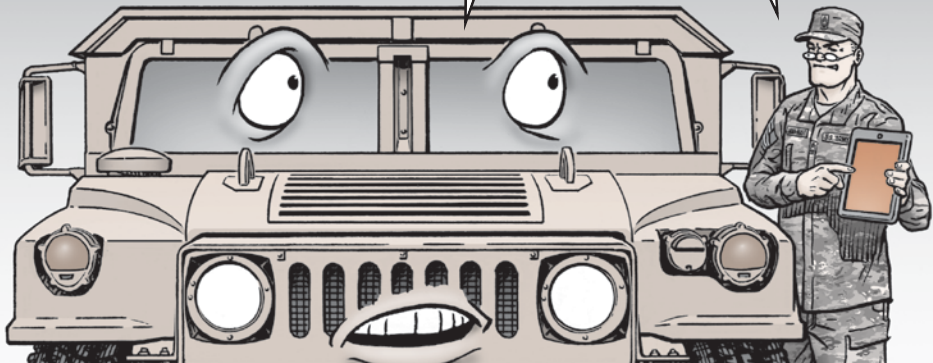

PS 639-60:

<https://www.logsa.army.mil/web2/archive/PS2006/639/639-60-61.pdf>

PS 762-11:

<https://www.logsa.army.mil/web2/archive/PS2016/762/762-11.pdf>

PS 736-6-7:

<https://www.logsa.army.mil/web2/archive/PS2014/736/736-06-07.pdf>

PS 760-18-19, 725-60 AND 722-17:

<https://www.logsa.army.mil/web2/archive/PS2016/760/760-18-19.pdf>

<https://www.logsa.army.mil/web2/archive/PS2013/725/725-60-61.pdf>

<https://www.logsa.army.mil/web2/archive/PS2013/722/722-17.pdf>

BUT NO ONE'S EVER ASKED WHAT TO DO WITH THE **OLD** DELAMINATED UP-ARMOR BALLISTIC GLASS WINDSHIELDS UNTIL A WISE READER RECENTLY EMAILED THESE QUESTIONS:

- IS THERE A TURN-IN PROCESS?
- ARE THE WINDSHIELDS RECYCLABLE?
- CAN THEY SIMPLY BE TRASHED?
- WHAT'S THE GUIDANCE ON THIS?

Demilitarization



NOW, SOME ANSWERS TO THOSE NAGGING QUESTIONS!

DELAMINATED UP-ARMOR BALLISTIC GLASS WINDSHIELDS HAVE A DEMIL CODE OF "D."

THIS MANDATES **TOTAL DESTRUCTION** OF THE ITEM IN SUCH A WAY THAT **PREVENTS** RESTORATION OR REPAIR.

THE **EASIEST** WAY TO DO THIS IS TO REMOVE THE PANELS FROM VEHICLES AND **WHACK** THEM WITH A BLUNT TOOL (SUCH AS A SLEDGE HAMMER) UNTIL THEY'RE SMASHED. JUST MAKE SURE YOU USE PERSONAL PROTECTIVE EQUIPMENT WHEN DESTROYING THE GLASS.

THIS MAY **SEEM** WASTEFUL, BUT BALLISTIC GLASS **ISN'T** RECYCLABLE. AND THE REGS REQUIRE "D" CODED ITEMS TO BE DEMILITARIZED IN THIS WAY TO **PREVENT** UNAUTHORIZED USE.

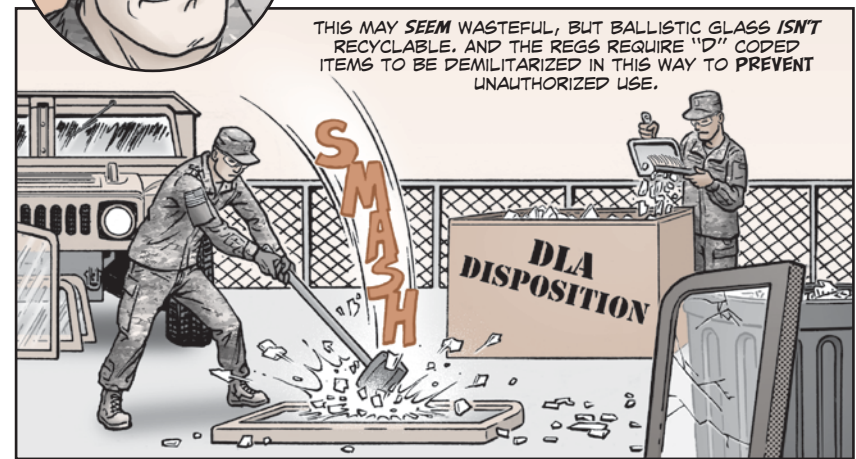

Turn-In Process

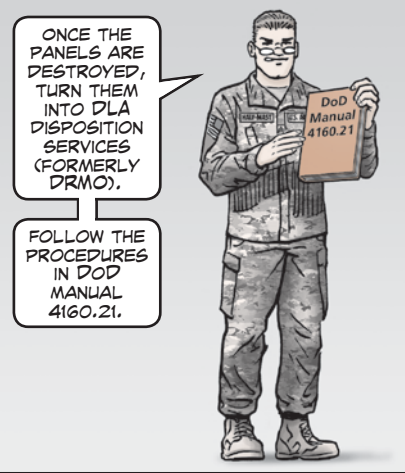

ONCE THE PANELS ARE DESTROYED, TURN THEM INTO DLA DISPOSITION SERVICES (FORMERLY DRMO).

FOLLOW THE PROCEDURES IN DOD MANUAL 4160.21.

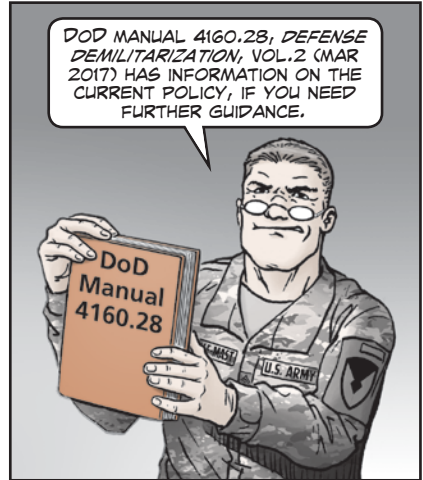

DOD MANUAL 4160.28, DEFENSE DEMILITARIZATION, VOL.2 (MAR 2017) HAS INFORMATION ON THE CURRENT POLICY, IF YOU NEED FURTHER GUIDANCE.



● **PM to Keep Your Buffalo Roaming**

M1272 Buffalo...

PM to Keep Your Buffalo Roaming

♪ I'M A BUFF-A-LOOO AT HOOOME... ♪
 ♪ RO-OH-OAMING WITH THESE TIPS! ♪

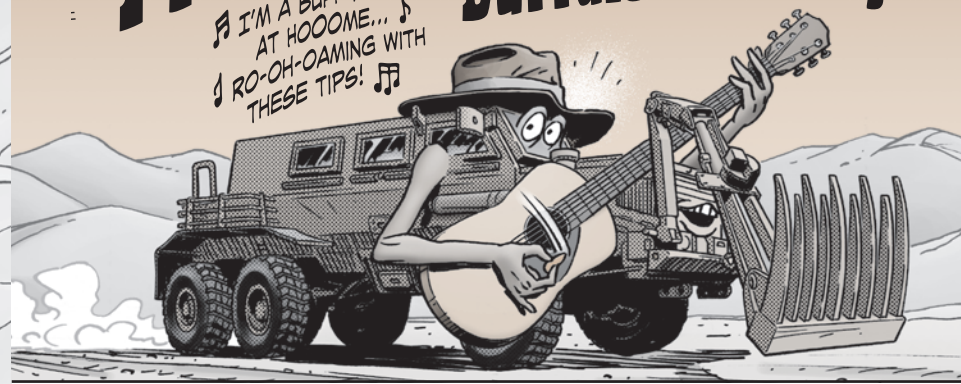

Dear Editor,
 While teaching Soldiers how to operate and maintain the Buffalo route clearance vehicle, I've come up with a few ways to keep the Buffalo clearing trails:

Vehicle won't start? Check the main electrical disconnect. Do this before doing any troubleshooting. Sometimes the switch gets flipped off during PMCS and not switched back on. Then crews think something major is wrong.

Check the red dot on the front and rear cameras. The dots should be at the 12 o'clock position. If they're not, the cameras won't give the right picture. Vibration usually knocks the cameras out of position. So always check the cameras before hitting the road.

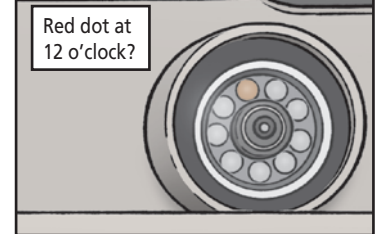

Red dot at 12 o'clock?

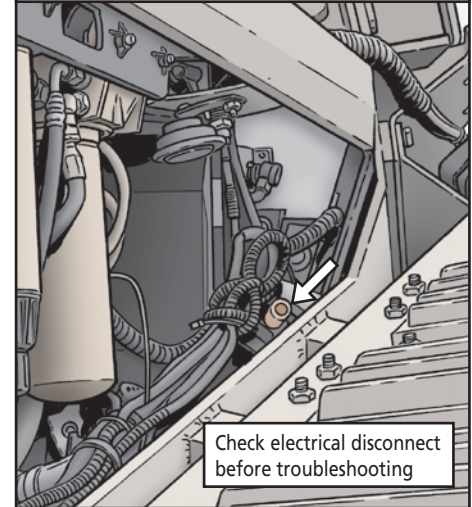

Check electrical disconnect before troubleshooting

Easy does it with the air tank pressure relief cables. Yanking on the cables eventually breaks them and it takes hours to replace a cable. Pull on the cable just until you hear air coming out. That's far enough.



Don't yank air tank pressure relief cables

Use two people to check the air digger compressor reservoir. To actually check the sight glass, you must remove three bolts on each side of the 95-lb door and then lower it. If you try to do that on your own, you'll end up walking funny.

Use a 17mm socket to remove the bolts while your helper holds the door. The sight glass should be $\frac{1}{2}$ to $\frac{3}{4}$ full.

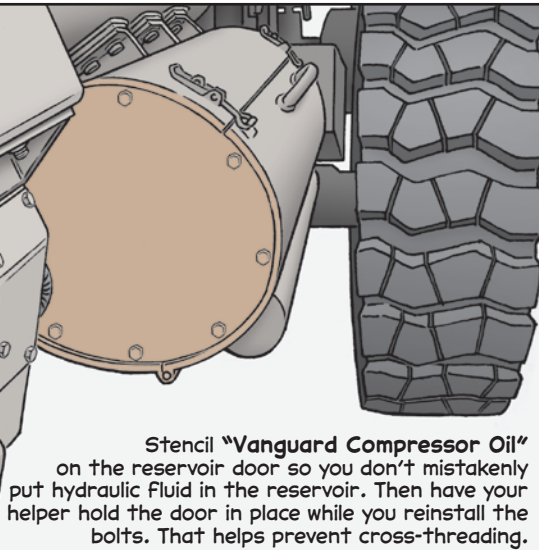

Keep fuel caps lubed. When fuel caps become difficult to turn, give their threads a light coat of GAA. Otherwise, the caps can eventually seize.

Don't let the fuel nozzle scrape the side of the fuel tank opening. Rust tends to form there. The nozzle breaks the rust loose and contaminates the fuel. The only way to clean out the rust is to drain the tank.

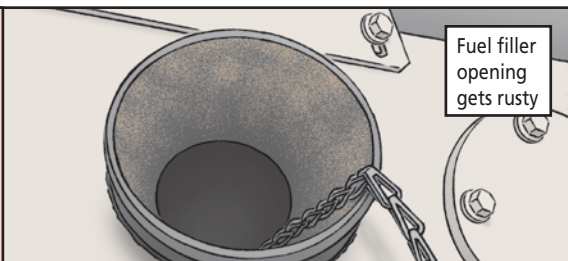

Easy does it with ladder. When crews exit the Buffalo, they sometimes let the ladder slam down. That bends the ladder and its hinge points and breaks the cable. Lower the ladder by its cable to avoid damage. And remember to lock the ladder in place once everyone gets inside the Buffalo. That way it won't slam down when you hit the first bump.

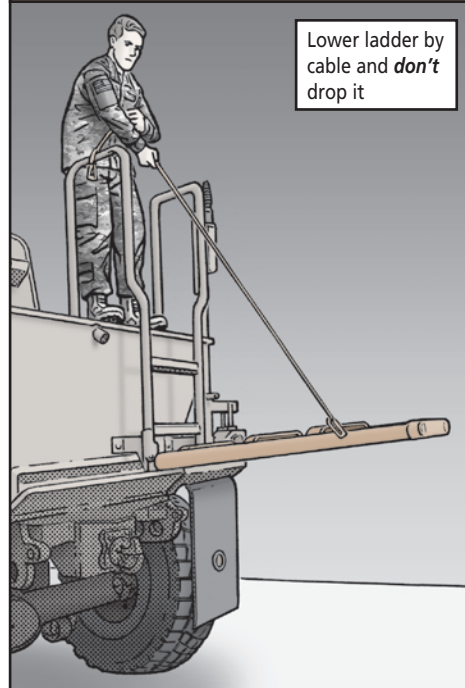

Step directly on the ladder release. If your foot is at an angle, you can damage the release. If the release sticks, lube it with CLP.

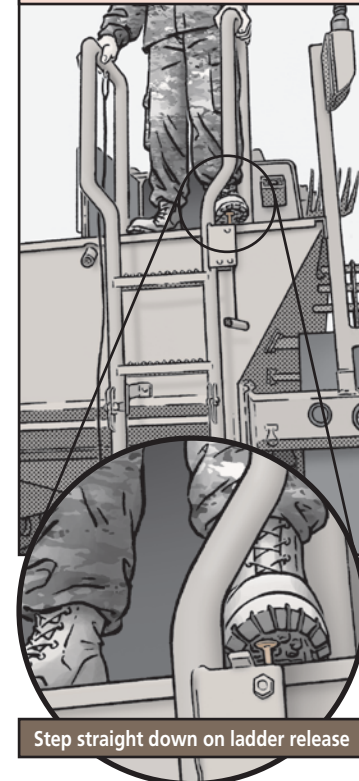

Remove the hydraulic tank fluid cover with a 19mm hex socket and a 1/2-in drive. The TM doesn't mention that these tools are required. As a result, the check is missed, which leads to arm failures.

19mm hex socket required but **not** mentioned in TM

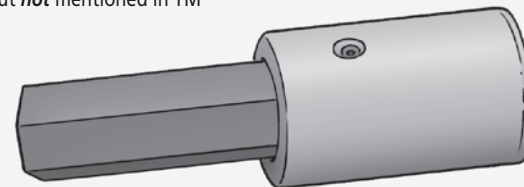

Air digger hose hung up? The hose coil is spring-loaded. If the spring is worn, the hose hangs up. Try raising the arm 45 degrees and then extend and retract it. That usually fixes it. If this happens a lot, tell your repairman so he can replace the spring.

Strap everything down before hitting the road, including yourself. Getting thrown around the vehicle or being hit by a Flying TM is as dangerous as the IEDs. I've seen Buffaloes completely stood on end by IEDs. If you're not wearing your seat belt, you could end up bouncing around like a pinball.

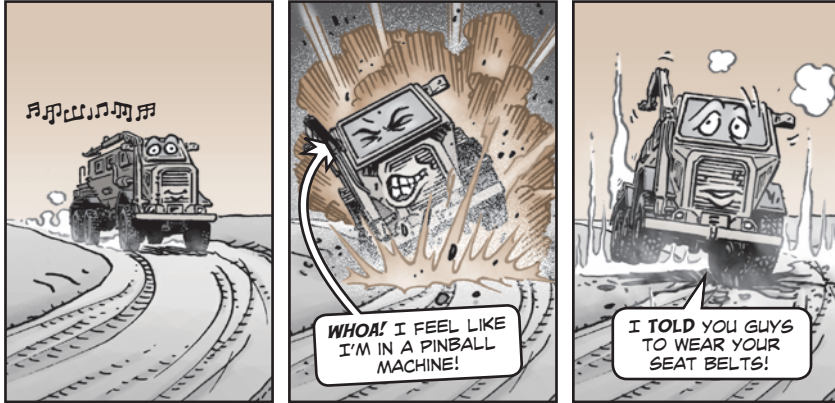

If it takes you less than two hours to do PMCS, you're not doing a complete PMCS. Take your time and follow all the PMCS steps in the TM.

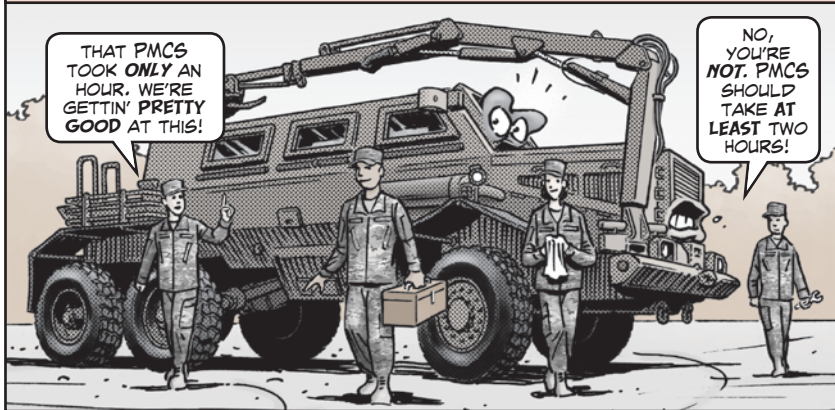

SSG David Wise
Ft Leonard Wood, MO

Editor's note: Your tips will indeed keep Buffaloes on the trail of mines. Very wise, SSG Wise. Thanks.

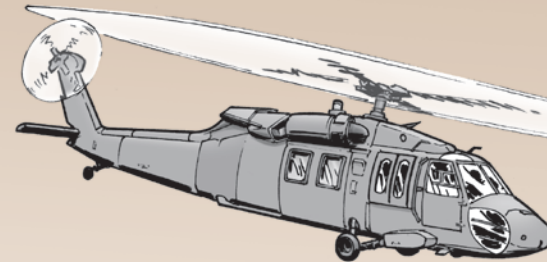

- Rescue Hoist Devices Require Inspections
- New Apache Flyer's Helmet TM Available
- T700 Engine Manual Only in IETM
- Don't Use Unauthorized Tool
- Need Shadow Help?
- TB 43-180 Released
- Need A2CU Flight Suit NSNs?

PS AVIATION

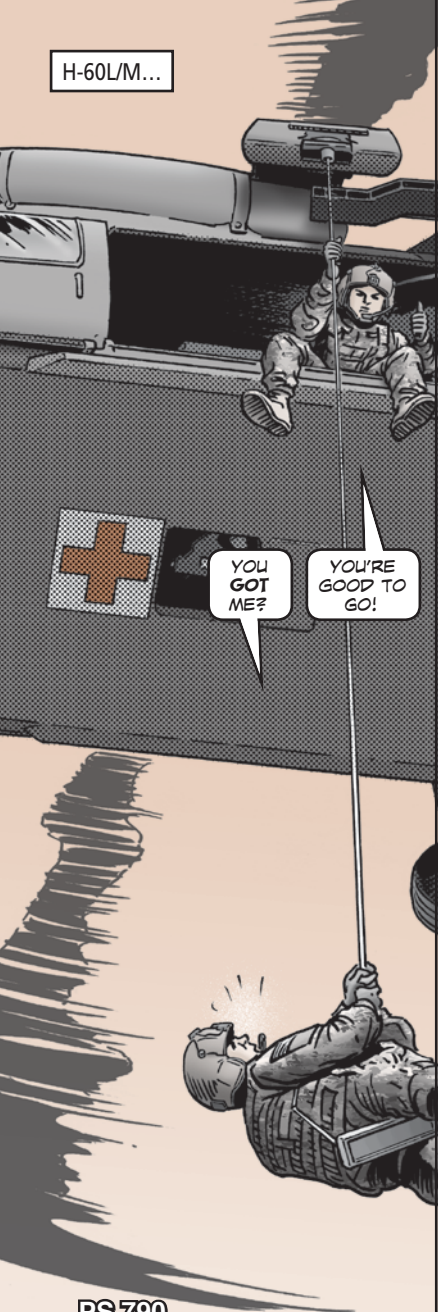

YOU GOT ME?

YOU'RE GOOD TO GO!

RESCUE HOIST DEVICES REQUIRE INSPECTIONS

PERFORMING INSPECTIONS AND MAINTENANCE ON RESCUE DEVICES ENSURES YOUR SAFETY.

CREWS, MEDEVAC RESCUE HOIST DEVICES PLAY AN IMPORTANT ROLE IN SAVING SOLDIER'S LIVES.

YOU PLAY A SIMILAR ROLE BY PROPERLY MAINTAINING AND INSPECTING THOSE DEVICES.

AWR 980 IDENTIFIES ALL AUTHORIZED RESCUE DEVICES THAT CAN BE ATTACHED TO THE HOIST. BUT SOME UNITS **DON'T** KNOW HOW TO INSPECT AND MAINTAIN HOIST DEVICES.

THAT'S WHERE AWR 980 COMES IN!

IT GIVES YOU MAINTENANCE, OPERATION AND INSPECTION INFORMATION FOR EACH RESCUE DEVICE.



FOR EXAMPLE, THE #420 RESCUE SEAT SHOULD BE MAINTAINED AND OPERATED BASED ON THE INSTRUCTIONS IN NAVAIR 13-1-6.5. IT SPECIFIES A PLACED-IN-SERVICE INSPECTION FOR THE SEAT, ALONG WITH A 180-DAY RECURRING INSPECTION THAT INCLUDES BOTH A TENSION AND LOAD TEST. THESE DEVICES MUST BE ABLE TO HOLD THE WEIGHT SO THEY DON'T FAIL DURING A RESCUE MISSION.

Inspect and maintain rescue seat like it says in AWR 980 and NAVAIR 13-1-6.5

IF YOU USE THE #420 RESCUE SEAT, HERE ARE SOME QUESTIONS FOR YOU:

WHEN WAS THE LAST TIME YOU LOADED EACH SEAT PADDLE WITH 250 POUNDS AND SUSPENDED IT FOR 30 MINUTES TO VERIFY A LOAD TEST?
HAS IT BEEN MORE THAN 180 DAYS SINCE THE LAST INSPECTION?
HOW DO YOU KNOW THE SEAT IS STILL SERVICEABLE?

IF YOU **CAN'T** ANSWER THESE QUESTIONS, GET THE REQUIRED INSPECTIONS DONE **BEFORE** YOU USE THE SEAT AGAIN. AND THE SAME GOES FOR ALL OTHER AUTHORIZED DEVICES FOR THE RESCUE HOIST.

IN ADDITION, MAKE SURE YOU TRACK THE INSPECTIONS FOR EACH RESCUE HOIST DEVICE. THAT'S THE ONLY WAY TO ENSURE PERSONNEL CAN BE RESCUED SAFELY.

I SURE AM GLAD THEY TAKE RESCUE SEAT MAINTENANCE SERIOUSLY.

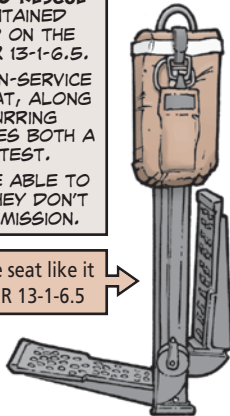

New Apache Flyer's Helmet TM Available

NOW THAT THE E-MODEL APACHE AVIATOR INTEGRATED HELMET (AAIH) SYSTEM HAS HIT THE STREETS, MAINTAINING IT BECOMES IMPORTANT. SO CRACK OPEN THE NEW TM 1-1680-392-13&P FOR ALL THE GOOD PMCS AND MAINTENANCE TIPS.



DOWNLOAD IT AT:
<https://iiv.logsa.army.mil/etmapp/#/etm/home>

T700 Engine Manual Only in IETM

FOR ALL T700-GE-700/701C/701D ENGINES, TM 1-2840-248-23&P ON EM 0271 (JUN 17) IS NOW AVAILABLE **ONLY** AS AN INTERACTIVE ELECTRONIC TECHNICAL MANUAL (IETM).

THE THREE PREVIOUS PDF MANUALS (TM 1-2840-248-23&P-1, -2 AND -3) ARE **RESCINDED**.

THAT'S BECAUSE OF THE NEW "PDF BUTTON" FEATURE WITHIN THE IETM THAT ALLOWS USERS TO OPEN EACH WORK PACKAGE (WP) IN PDF FORMAT.

DON'T USE UNAUTHORIZED TOOL

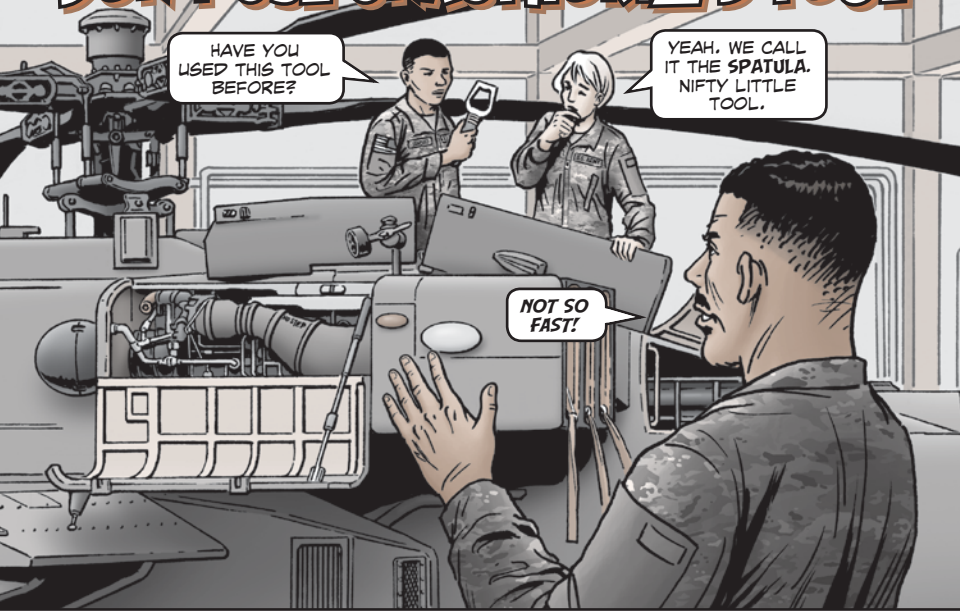

HAVE YOU USED THIS TOOL BEFORE?

YEAH. WE CALL IT THE SPATULA. NIFTY LITTLE TOOL.

NOT SO FAST!

THAT NIFTY TOOL, PN 7-3640610003-53, AND **ANY** VERSION OF IT IS **NOT** AUTHORIZED AT YOUR LEVEL OF MAINTENANCE AND SHOULD BE **DISCARDED**.

THERE'S A LEAD LAG LINK ALIGNMENT TOOL, BUT THAT'S ONLY FOR **DEPOT-LEVEL** MAINTENANCE.



MECHANICS, AVIATION SAFETY ACTION MESSAGE, AH-64-07-ASAM-11, AND THE AH-64 IETM INSTRUCT YOU TO **CHECK** FOR A GAP GREATER THAN .020 INCHES BETWEEN THE BEARING CAP AND THE RETAINER EVERY 25 FLIGHT HOURS.

IF THE GAP CANNOT BE REDUCED BELOW .020 INCHES BY RESEATING OR REPLACING THE RETAINER, THE IETM AND THE ASAM TELL YOU TO **REMOVE** THE MAIN ROTOR BLADE AND THE LEAD LAG LINK ASSEMBLY TO REPLACE THE HUB BEARING.

TO ACCOMPLISH THE TASK, **SOME** MAINTAINERS HAVE BEEN USING AN **UNAUTHORIZED** HOMEMADE TOOL—THE LEAD LAG LINK BEARING CUP WRENCH, OR SPATULA—TO TURN THE BEARING CAP BACK INTO POSITION DURING REPLACEMENT OR THE 25-HOUR GAP INSPECTION.

WHILE THIS **MAY** SAVE TIME, THE TOOL COULD BE **MASKING** INTERNAL WEAR THAT CAUSES THE CAPS TO ROTATE IN THE FIRST PLACE.

WHEN IT COMES TO RESOURCEFULNESS, MOST AIRCRAFT MECHANICS HAVE A PHD. USING THIS TOOL MAY **SEEM** LOGICAL, **BUT** IN THIS CASE, SIDE-STEPPING MAINTENANCE PROCEDURES AND USING AN UNAUTHORIZED TOOL IS **NOT** THE SMART THING TO DO.

VARIATIONS OF THIS TOOL HAVE BEEN FOUND IN MANY APACHE MAINTENANCE SHOPS.

IF YOU HAVE ANY, GET RID OF THEM NOW!

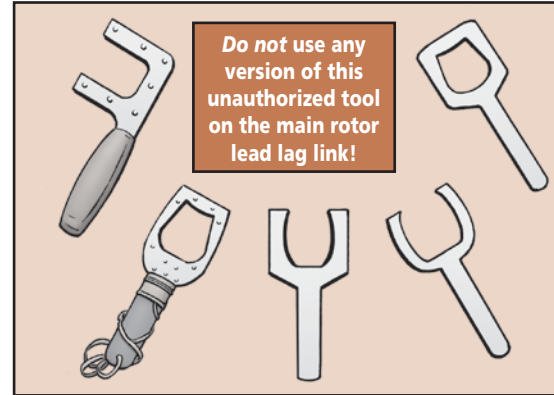

Remember:

UNAUTHORIZED TOOLS AND MAINTENANCE PRACTICES CAN **CAUSE** MORE AIRCRAFT **DAMAGE** THAN THEY PREVENT.

FOR **MORE INFORMATION**, CHECK OUT H-64-16-AMAM-02. LOG IN AT:

<https://asmprd.redstone.army.mil/default.aspx>

THEN TYPE IN THIS URL:

https://asmprd.redstone.army.mil/FileHandler.ashx?file=UFI_67afe2ff-c69a-41d3-9822-457d44af5122

BE SAFE RATHER THAN SORRY. MAKE SURE ANY AND ALL MAINTENANCE ON YOUR APACHE IS DONE FOLLOWING DA-AUTHENTICATED TECHNICAL MANUALS AND APPROVED TOOLS.



Need Shadow Help?

When trouble arises with your Shadow unmanned aircraft, the Textron helpdesk is ready to support your needs. You can reach them at (410) 628-4700 or email:

shadowhelpdesk@aai.textron.com

You can also reach the government Shadow office at:

usarmy.redstone.peo-avn.list.shadow-help@mail.mil

TB 43-180 Released

TB 43-180, *Calibration and Repair Requirements for the Maintenance of Army Material*, is updated monthly and is now available on the LOGSA ETM website:

<https://liw.logsa.army.mil/etmapp/#/etm/home>

Check it out for the latest on calibration and repair for your equipment.

Clothing...

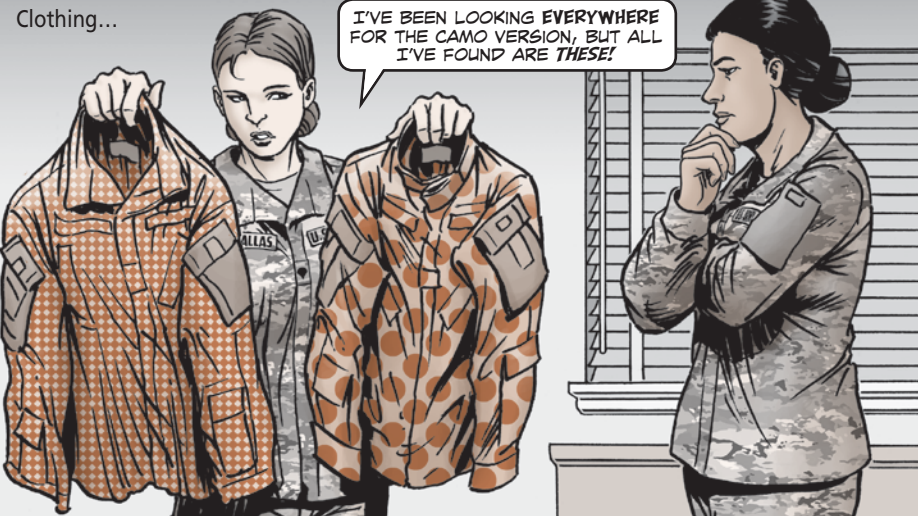

I'VE BEEN LOOKING EVERYWHERE FOR THE CAMO VERSION, BUT ALL I'VE FOUND ARE THESE!

Need A2CU Flight Suit NSNs?

IF YOU'VE BEEN LOOKING FOR THE ARMY AVIATION COMBAT UNIFORM (A2CU) FLIGHT SUIT WITH THE OPERATIONAL CAMOUFLAGE PATTERN (OCP)...

...HERE ARE THE LATEST NSNs...

Coat Size	NSN 8145-
XS short	01-641-3701
XS reg	01-641-3707
XS long	01-641-3709
S short	01-641-3715
S reg	01-641-3723
S long	01-641-3724
M short	01-641-3725
M reg	01-641-3727
M long	01-641-3729
L short	01-641-3730
L reg	01-641-3732
L long	01-641-3736
XL short	01-641-3737
XL reg	01-641-3739
XL long	01-641-3741



Trouser Size	NSN 8145-
XS short	01-641-4036
XS reg	01-641-4043
XS long	01-641-4056
S short	01-641-4057
S reg	01-641-4059
S long	01-641-4063
M short	01-641-4065
M reg	01-641-4066
M long	01-641-4068
L short	01-641-4071
L reg	01-641-4072
L long	01-641-4074
XL short	01-641-4075
XL reg	01-641-4076
XL long	01-641-4077

DAX TORTHON IN THE 26TH CENTURY



I'M DAX TORTHON, CAPTAIN OF THE UNITED STAR SYSTEMS OF ORION-CYGNUS SHIP STAR STRIDER.

THE CREW OF THIS SHIP PERFORMS A CRUCIAL MISSION: WE PROTECT THE USSO-C FROM THE LOTHANKIAN SPACE PIRATES.

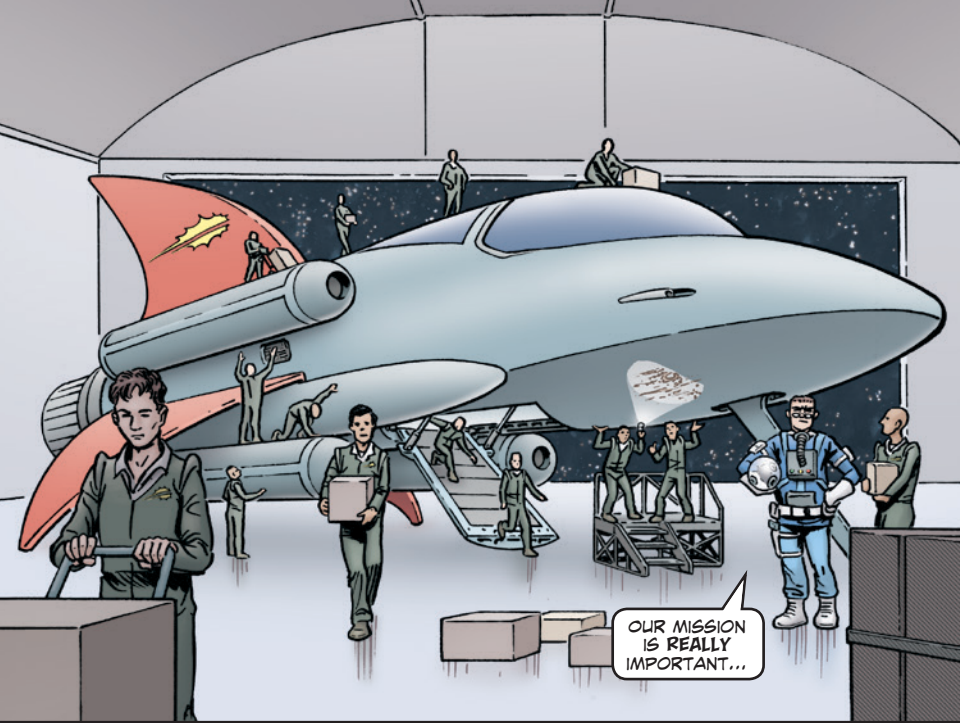

THE MECHANICS MAKE SURE THAT SHE FLIES STRAIGHT AND TRUE, THAT THE SYSTEMS ARE ALWAYS PROPERLY CALIBRATED AND THAT OUR HULL PLATING WILL PROTECT US FROM BLASTS.



WITHOUT PREVENTIVE MAINTENANCE THE STAR STRIDER COULDN'T PERFORM ITS MISSION.



THE STAR STRIDER RACKS UP A LOT OF FLYING HOURS.

WE MAKE SURE THAT THE FLIGHT SURFACES, THE CONTROL ARRAYS AND ALL OF THE EXTERNAL SENSORS STAY IN GOOD REPAIR.



THE CREW'S SAFETY DEPENDS ON US DOING OUR JOB BY THE BOOK.

...ALMOST AS IMPORTANT AS THE WORK THAT HAPPENS IN THIS HANGER.

THIS IS WHERE THE MECHANICS PERFORM PREVENTIVE MAINTENANCE ON THE STAR STRIDER.

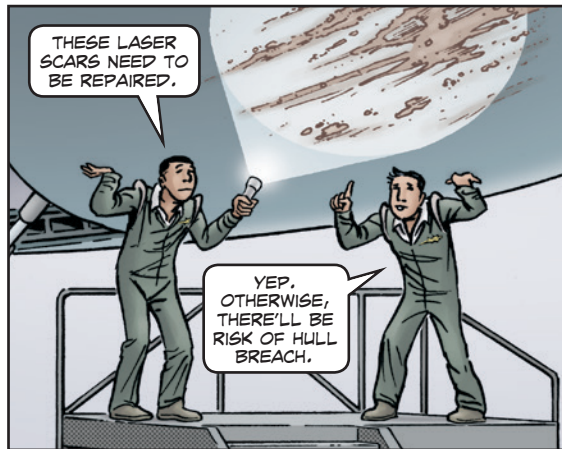

THESE LASER SCARS NEED TO BE REPAIRED.

YEP, OTHERWISE, THERE'LL BE RISK OF HULL BREACH.

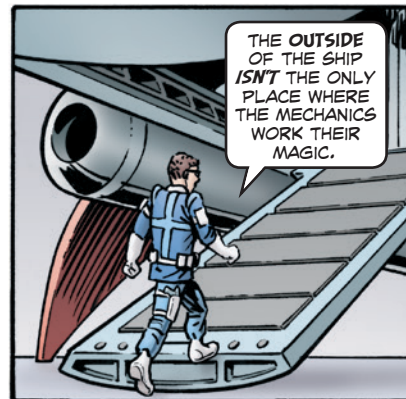
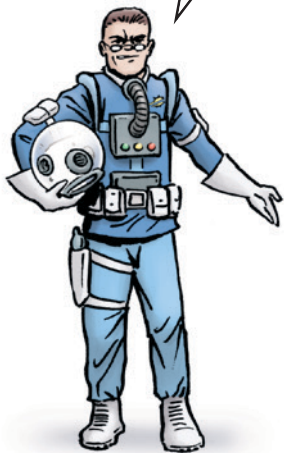

THE OUTSIDE OF THE SHIP ISN'T THE ONLY PLACE WHERE THE MECHANICS WORK THEIR MAGIC.



THERE ARE PLENTY OF THINGS ON THE INSIDE THAT ALSO NEED PM.

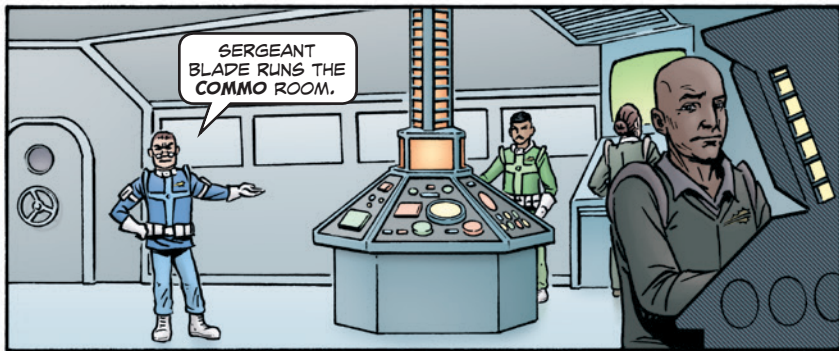

SERGEANT BLADE RUNS THE COMMO ROOM.



THERE ARE LOTS OF THINGS TO KEEP AN EYE ON IN SPACE BESIDES THE LOTHANKIAN SPACE PIRATES.

WE MAKE SURE THAT THE EYES AND THE EARS OF THE STAR STRIDER ARE ALWAYS READY TO HELP DAX AND HIS CREW PROTECT THE USSO-C.

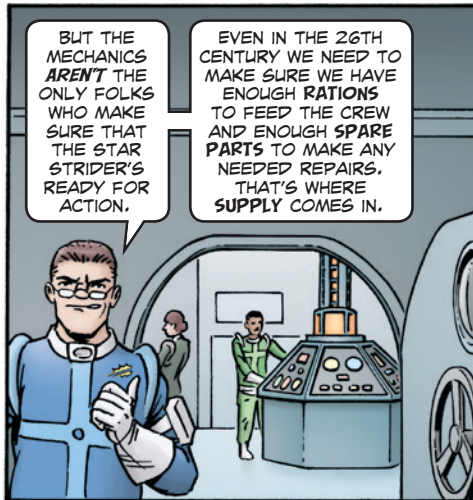

BUT THE MECHANICS *AREN'T* THE ONLY FOLKS WHO MAKE SURE THAT THE STAR STRIDER'S READY FOR ACTION.

EVEN IN THE 26TH CENTURY WE NEED TO MAKE SURE WE HAVE ENOUGH RATIONS TO FEED THE CREW AND ENOUGH SPARE PARTS TO MAKE ANY NEEDED REPAIRS. THAT'S WHERE SUPPLY COMES IN.

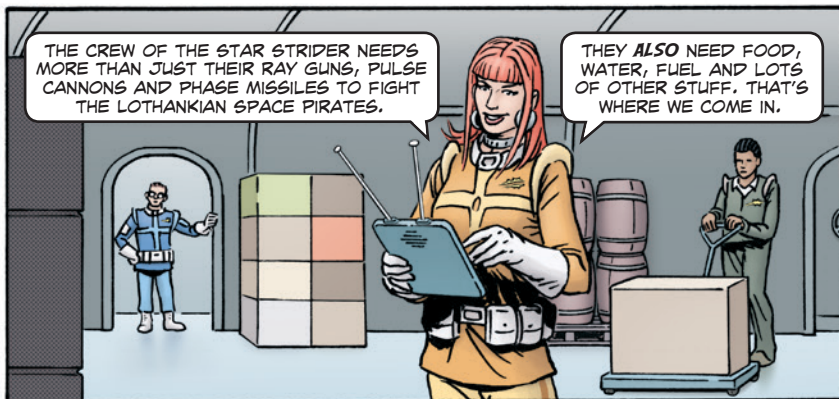

THE CREW OF THE STAR STRIDER NEEDS MORE THAN JUST THEIR RAY GUNS, PULSE CANNONS AND PHASE MISSILES TO FIGHT THE LOTHANKIAN SPACE PIRATES.

THEY *ALSO* NEED FOOD, WATER, FUEL AND LOTS OF OTHER STUFF. THAT'S WHERE WE COME IN.

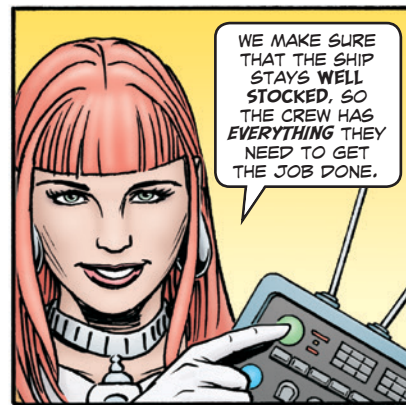

WE MAKE SURE THAT THE SHIP STAYS WELL STOCKED, SO THE CREW HAS *EVERYTHING* THEY NEED TO GET THE JOB DONE.

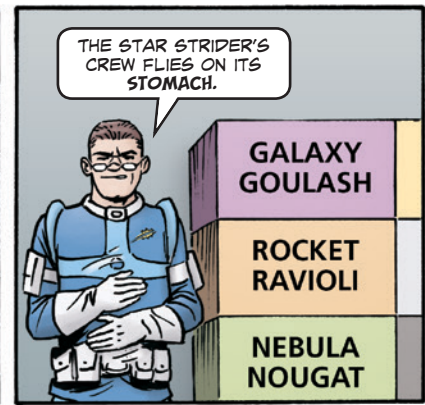

THE STAR STRIDER'S CREW FLIES ON ITS STOMACH.

GALAXY GOULASH

ROCKET RAVIOLI

NEBULA NOUGAT

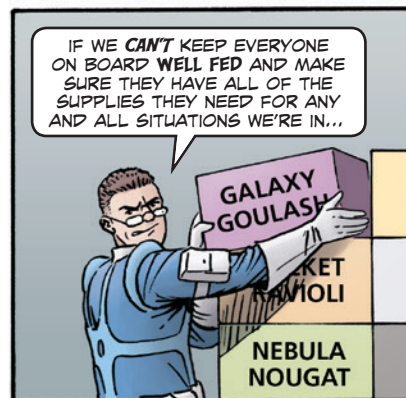

IF WE *CAN'T* KEEP EVERYONE ON BOARD WELL FED AND MAKE SURE THEY HAVE ALL OF THE SUPPLIES THEY NEED FOR ANY AND ALL SITUATIONS WE'RE IN...

GALAXY GOULASH

ROCKET RAVIOLI

NEBULA NOUGAT

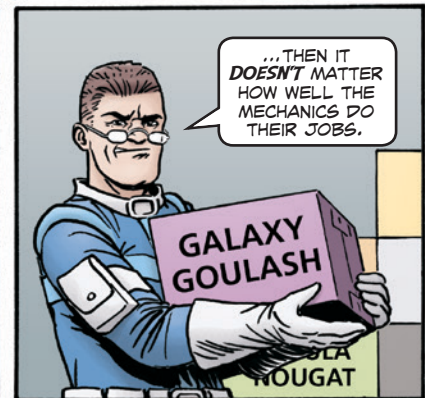

...THEN IT *DOESN'T* MATTER HOW WELL THE MECHANICS DO THEIR JOBS.

GALAXY GOULASH

ROCKET RAVIOLI

NEBULA NOUGAT

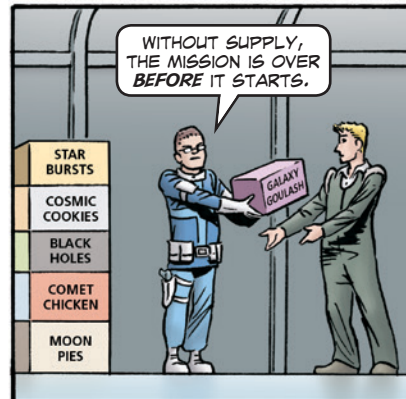

WITHOUT SUPPLY, THE MISSION IS OVER *BEFORE* IT STARTS.

STAR BURSTS

COSMIC COOKIES

BLACK HOLES

COMET CHICKEN

MOON PIES

GALAXY GOULASH



C'MON. OUR *NEXT* STOP IS THE BRIDGE.

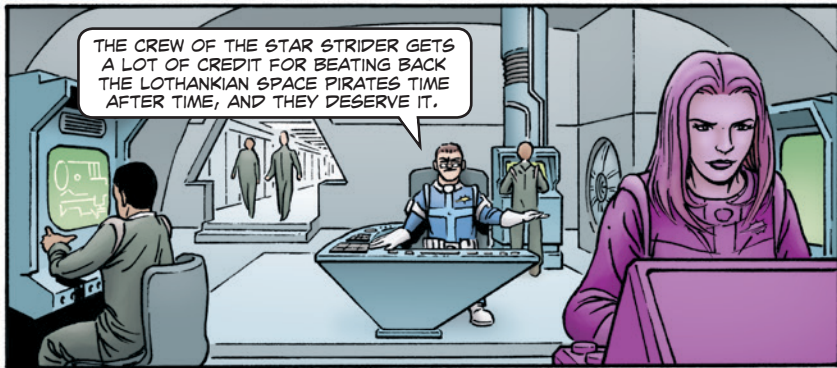

THE CREW OF THE STAR STRIDER GETS A LOT OF CREDIT FOR BEATING BACK THE LOZHANKIAN SPACE PIRATES TIME AFTER TIME, AND THEY DESERVE IT.

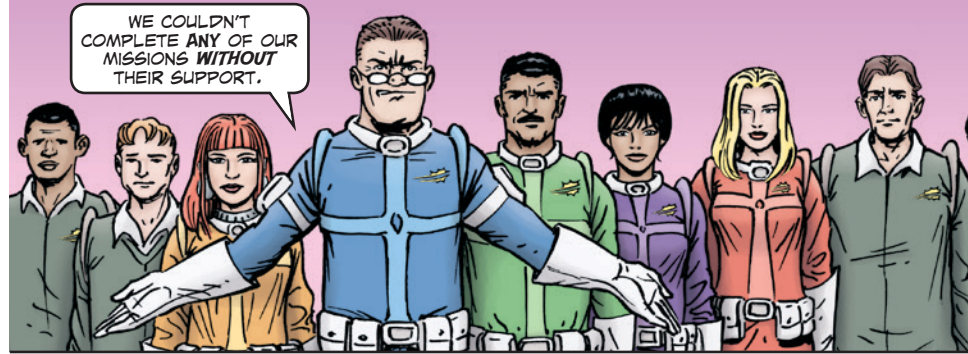

WE COULDN'T COMPLETE ANY OF OUR MISSIONS *WITHOUT* THEIR SUPPORT.



THEY WORK HARD AND TRAIN FOR EVERYTHING THEY MIGHT ENCOUNTER IN SPACE...

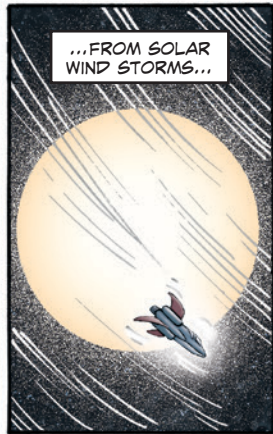

...FROM SOLAR WIND STORMS...



...TO TULKRATHIAN SPACE SLUGS!



I CAN ONLY *IMAGINE* PROTECTING THE UNITED STAR SYSTEMS OF ORION-CYGNUS *WITHOUT* GOOD PREVENTIVE MAINTENANCE AND LOGISTICS.

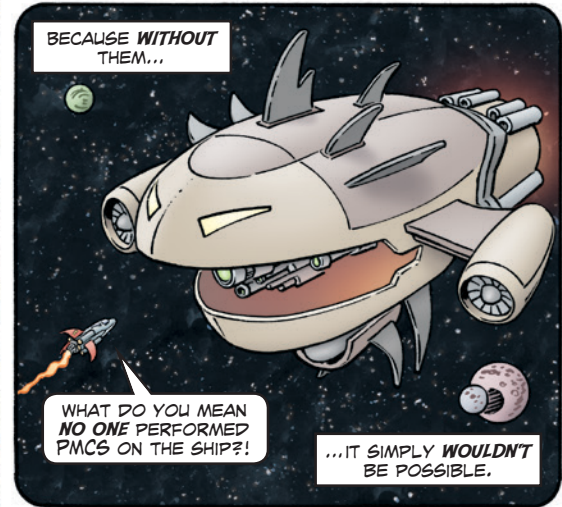

BECAUSE *WITHOUT* THEM...

WHAT DO YOU MEAN *NO ONE* PERFORMED PMCS ON THE SHIP?!

...IT SIMPLY *WOULDN'T* BE POSSIBLE.

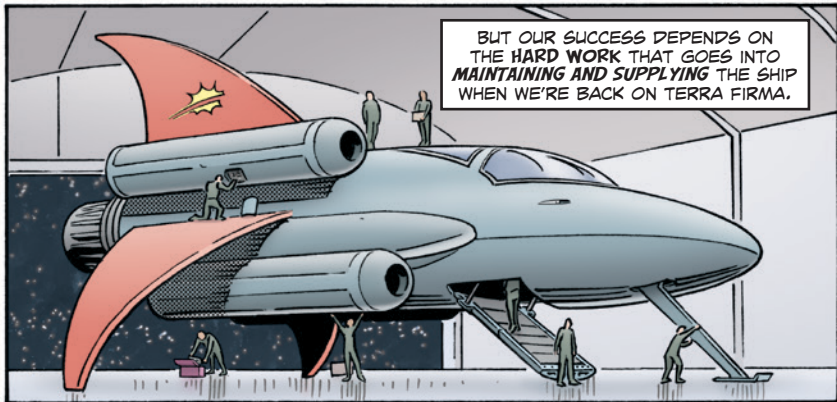

BUT OUR SUCCESS DEPENDS ON THE *HARD WORK* THAT GOES INTO *MAINTAINING AND SUPPLYING* THE SHIP WHEN WE'RE BACK ON TERRA FIRMA.

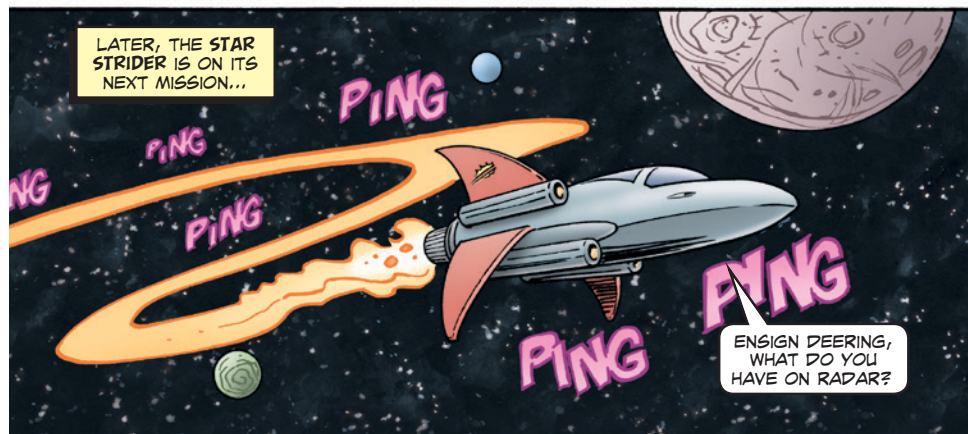

LATER, THE STAR STRIDER IS ON ITS NEXT MISSION...

ENSIGN DEERING, WHAT DO YOU HAVE ON RADAR?

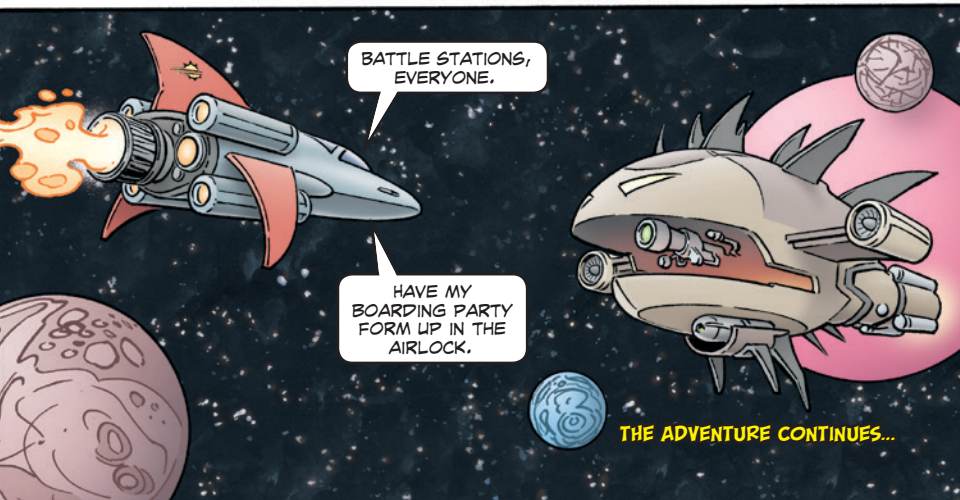
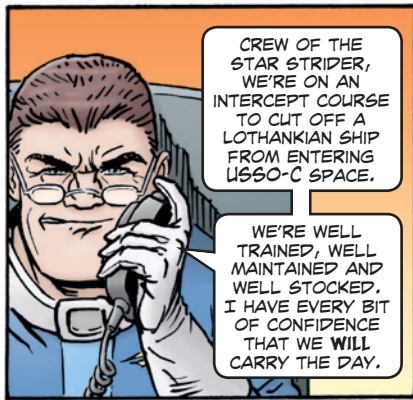
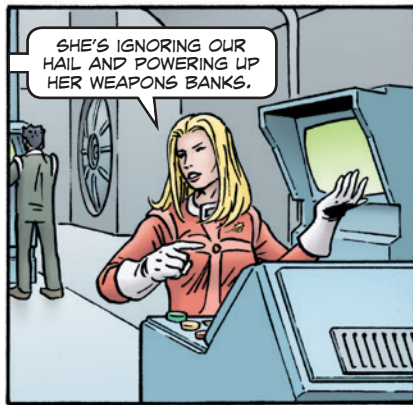
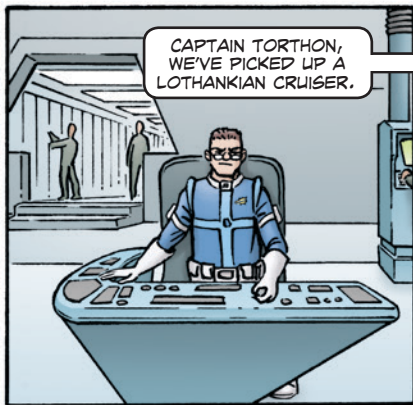

PS SMALL ARMS



- You Have Cleaning Choices!
- Items Added to M249 AAL
- Lock it or Lose it
- Hammer Not Needed... But Grease Is!
- Turn-in for Sights Change

**ALSO
FEATURING
MINES**

- Your Minehound Can Hunt... If You Remember These Tips!

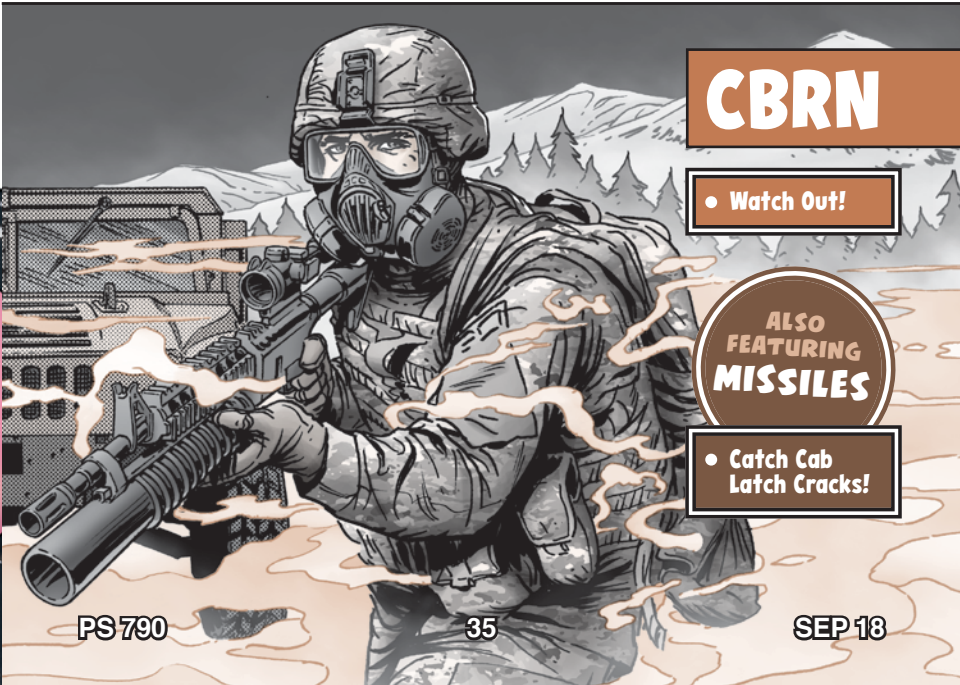

CBRN

- Watch Out!

**ALSO
FEATURING
MISSILES**

- Catch Cab Latch Cracks!

M16-Series Rifle,
M4/M4A1 Carbine...

YOU HAVE CLEANING CHOICES!

WHEN IT COMES TO CLEANING YOUR M16 RIFLE OR M4/M4A1 CARBINE, YOU HAVE CHOICES...

THE CONVENIENCE OF A KIT OR THE ECONOMY OF ORDERING CLEANING TOOLS INDIVIDUALLY.



THE IMPROVED CLEANING KIT, NSN 1005-01-562-7393, WHICH WAS THE FIRST APPROVED KIT, IS NOW **OBSELETE**.

SO DON'T ORDER IT.

YOUR CHOICES ARE NOW THE INDIVIDUAL CLEANING KIT WITH MULTI-PURPOSE TOOL, NSN 1005-01-653-9588, AND THE SAME KIT *WITHOUT* THE TOOL, NSN 1005-01-624-1673.

THE KIT WITH TOOL COSTS MORE THAN \$300 AND *WITHOUT* THE TOOL COSTS JUST OVER \$100.



HERE'S WHAT COMES WITH THE KIT...

Item	NSN
5.56mm slotted tip swab patch holder	1005-01-449-9315
5.56mm cotton swab patches	1005-01-449-9257
5.56mm chamber brush	1005-01-544-7698
Double-ended tooth brush	1005-01-578-9925
Cleaning rod handle section	1005-01-581-8146
Cleaning rod section	1005-00-050-6357
NATO adapter	1005-01-449-9674
30-in rifle/machine gun cleaning cable	1005-01-449-8934
5.56mm bore brush	1005-01-449-8980
Empty refillable bottle	1005-00-242-5687
5.56mm ripcord	1005-01-629-3981
Multi-purpose tool	5110-01-394-6252



THE CHEAPER OPTION IS TO ORDER CLEANING TOOLS INDIVIDUALLY...

Item	NSN
Maintenance equipment case	8465-00-781-9564
Cleaning rod handle section	1005-01-113-0321
Cleaning rod sections (box of 25)	1005-00-050-6357
Swab holder	1005-00-937-2250
Bore brush	1005-00-903-1296
Chamber brush	1005-00-999-1435
Toothbrush	1005-00-494-6602
Cleaning brush	7920-00-205-2401
CLP, ½-oz bottle	9150-01-102-1473
Pipe cleaners (box of 1,344)	9920-00-292-9946
Small arms swab (1,000)	1005-00-912-4248

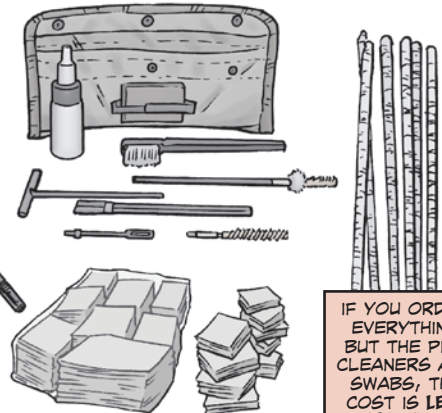

IF YOU ORDER EVERYTHING BUT THE PIPE CLEANERS AND SWABS, THE COST IS LESS THAN \$30.

THE ARMY RECOMMENDS THAT UNITS ALSO ORDER TWO TEAM CLEANING KITS, NSN 1005-01-653-9567, PER SQUAD.

THAT'S ONE PER FIRE TEAM.

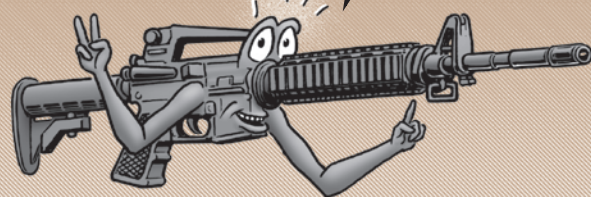

THE TEAM KIT INCLUDES CLEANING ITEMS LIKE:

- scrapers
- picks
- lens brushes
- ripcords

THAT CAN BE USED ON

- » pistols
- » rifles
- » carbines
- » machine guns

THE KIT COSTS AROUND \$130.

Items Added to M249 AAL



THE ARMY HAS ADDED MORE TOOLS TO THE M249 MACHINE GUN'S ARSENAL.

MORE HELP? GOOD!

THE FOLLOWING HAVE BEEN ADDED TO THE M249'S ADDITIONAL AUTHORIZED LIST (AAL)...

Item	NSN	PN
Magazine, cartridge (200-round softpack)	1005-01-560-5162	13020698
Short barrel BFA (yellow)	1005-01-537-0491	13013543
Multi-tool, folding (Gerber®)	5110-01-641-4777	30-00853
Grip, rifle	1005-01-521-1618	13008484
Cheekrest assembly, extended	1005-01-591-5779	13026056

Short barrel BFA

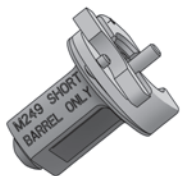

Rifle grip

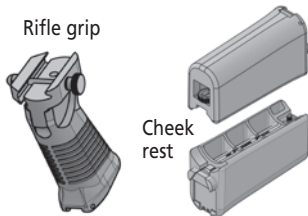

Multi-tool

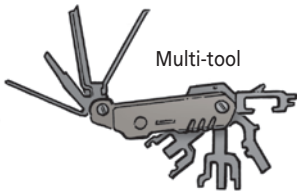

Cheek rest

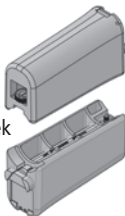

THESE ITEMS WILL BE ADDED TO THE REST OF THE AAL IN TM 9-1005-201-10.

M320/M320A1 Grenade Launcher...

LOCK IT OR LOSE IT

TACOM'S BUCK SEWELL HAS IMPORTANT INFO FOR SOLDIERS WHO USE THE M320 GRENADE LAUNCHER.



THANKS, MASTER SERGEANT HALF-MAST.

IF YOU FIRE THE M320/M320A1 GRENADE LAUNCHER WHILE FULLY EXTENDING ITS BUTTSTOCK, THE VERTICAL LOCKING LATCH **BANGS** INTO THE RECEIVER.

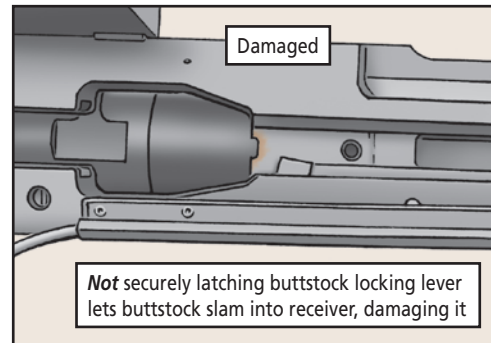

DO THAT EVEN A COUPLE OF TIMES AND THE RECEIVER GETS **CHIPPED**.

ONCE THE RECEIVER IS CHIPPED, THE VERTICAL LATCH **CAN'T** HOLD THE BUTTSTOCK ON THE WEAPON.

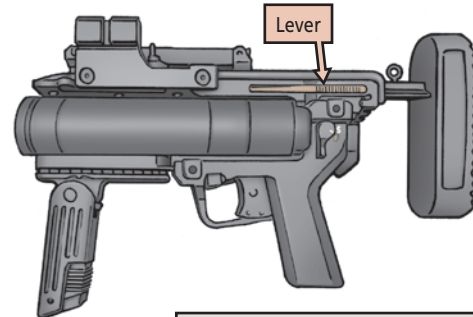

THE **RIGHT** WAY IS TO DEPRESS THE SERRATED END OF THE BUTTSTOCK LOCKING LEVER TO POSITION THE BUTTSTOCK.

MAKE SURE THE BUTTSTOCK LOCKING LEVER IS **SECURELY** LATCHED AFTER EXTENDING THE BUTTSTOCK SO THE BUTTSTOCK **DOESN'T** CHIP THE RECEIVER.

Depress serrated end of buttstock locking lever to position buttstock

DURING PMCS, CHECK THE RECEIVER FOR:

- **BURRS**
- **NICKS**
- **WEAR**
- **CHIPPING**

AS LONG AS THE DAMAGED AREA IS **NOT** MORE THAN 1/4-INCH IN DIAMETER, YOUR SMALL ARMS REPAIRMAN CAN FILE THE AREA SMOOTH AND COAT WITH SOLID FILM LUBRICANT.

IF THE DAMAGED AREA IS **LARGER**, TURN IN THE GRENADE LAUNCHER.

HAMMER NOT NEEDED... BUT GREASE IS!

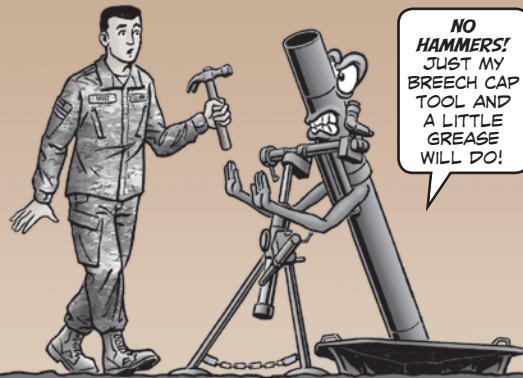

Dear Editor,

As a TACOM LAR, I see mortar units use a hammer to tighten the breech caps on M120A1 mortars too often. That can cause the barrel's white line not to align with the firing pin, which shortens the M120mm cannon's life.

The correct way to install the breech cap, according to WP 0031-2 in TM 9-1015-256-13&P, is to first give the breech cap threads a light coat of GAA grease. Then tighten the breech cap by using the cap removal tool. Back off a quarter turn and then use a jerking motion to finish tightening the cap. The white line on the barrel **must** line up with the firing pin.

Firing pin should align with white line on barrel

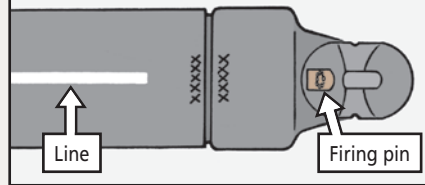

Elena Winchester
Ft Drum, NY

Editor's note: *If mortar crews follow the TM, they'll eliminate most firing problems. Thanks, Elena.*

Turn-in for Sights Change

MY REPAIR AND TURN-IN PROCEDURES HAVE CHANGED!

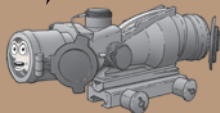

THE **M150 RIFLE COMBAT OPTIC (RCO)**, NSN 1240-01-557-1897, AND **ADVANCED COMBAT OPTICAL GUNSIGHT (ACOG)**, NSN 1240-01-534-1114, ARE **NO LONGER** BEING SENT TO THEIR MANUFACTURER FOR TURN-IN.

FOR TURN-IN, UNITS SHOULD CHECK FOR THE LATEST DISPOSITION INSTRUCTIONS AT TULSA OR ON THE DECISION SUPPORT TOOL (DST).

GO TO TULSA AT: <https://tulsa.tacom.army.mil/>
GO TO DST AT THE LOGISTICS INFORMATION WEBSITE (LIW): <https://liw.logsa.army.mil>

CONTACT THE TACOM OPTICS AND BINOCULARS TEAM AT: usarmy.detroit.tacom.mbx.ilsc-optics@mail.mil OR CONTACT **CHRIS KLINE** AT DSN 786-1357, (586) 282-1357, OR EMAIL: christopher.m.kline4.civ@mail.mil

THE M150'S TM 9-1240-416-13&P IS BEING UPDATED WITH THIS NEW INFORMATION.

Your Minehound Can Hunt... If You Remember These Tips!

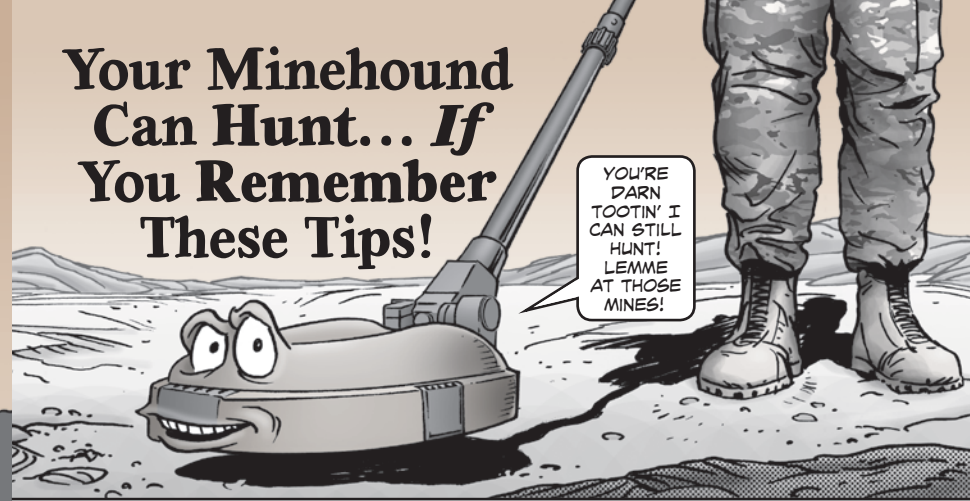

Get the Powerhound Kit

IT'S AN ADDITIONAL ITEM THAT **DOESN'T** COME WITH THE MINEHOUND. THE POWERHOUND KIT **GREATLY INCREASES** OPERATION TIME BECAUSE IT MAKES IT POSSIBLE TO USE BB-2590 AND BB-2557 MILITARY STANDARD BATTERIES. THE BB-2590 PROVIDES AROUND 32 HOURS OF OPERATIONS AND THE BB-2557 11 HOURS. THESE ARE THE **ONLY** APPROVED BATTERIES FOR THE POWERHOUND. GET THE **POWERHOUND POWER ADAPTER** WITH NSN 6130-01-641-3160, THE **BATTERY POUCH** WITH NSN 6665-01-644-1835 AND **POWER CABLE** WITH NSN 5995-01-641-5061.

THE VMR2 OR VMR2+ MINEHOUND WILL HUNT DOWN MINES IF YOU REMEMBER THESE TIPS:

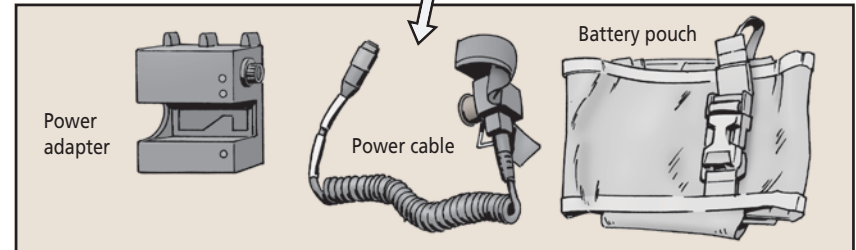

Get the Extra Strap

THE MINEHOUND COMES WITH A SHOULDER SLING, BUT YOU CAN ALSO GET AN OPTIONAL WEIGHT MITIGATION STRAP FROM YOUR FORWARD SUPPORT. THE EXTRA STRAP BETTER DISTRIBUTES THE WEIGHT OF THE MINEHOUND, WHICH MEANS LESS FATIGUE FOR YOU AND BETTER FOCUS. GENERALLY, OPERATORS SHOULD ROTATE EVERY 20 MINUTES TO AVOID FATIGUE.



Practice Battery Basics

NO JUICE MEANS NO DETECTING. AS PART OF YOUR BEFORE PMCS, TEST THE SPRING-LOADED BATTERY CONTACTS FOR TENSION.

YOU SHOULD BE ABLE TO DEPRESS THE CONTACTS AND SEE THEM MOVE. IF THEY **DON'T MOVE OR DON'T SPRING BACK WHEN RELEASED**, TELL YOUR REPAIRMAN.

ALSO LOOK FOR PITTING AND OTHER SIGNS OF ARCING. THEY INDICATE POOR BATTERY CONTACT.

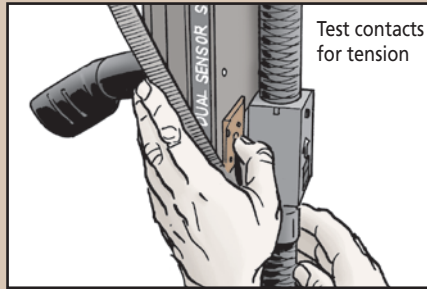

Clean the Contacts with a No. 2 Pencil Eraser

WIPE OFF THE CONTACTS WITH A CLEAN, SOFT CLOTH.

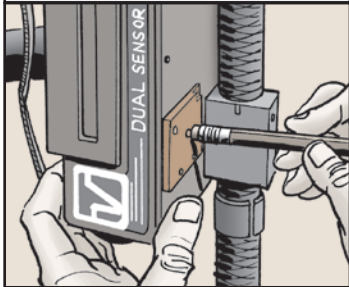

Don't Muscle Up On the Telescopic Pole and Search Head Brake Screws

FORCING THE SCREWS BREAKS THEM. USE **ONLY** THE NON-METALLIC TEST PIECE TO ADJUST THEM.

THE MINEHOUND SHOULD BE ABLE TO STAND STRAIGHT ON ITS OWN WITH THE TELESCOPIC POLE FULLY EXTENDED, BUT YOU SHOULD STILL BE ABLE TO ADJUST THE SEARCH HEAD.

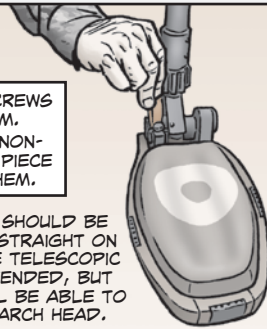

Keep Your Distance

STAY **AT LEAST TWO METERS AWAY** FROM OTHER MINEHOUND OPERATORS. IF THERE ARE **FOUR OR MORE OPERATORS**, MAKE THAT **10 METERS**. OTHERWISE, YOU'LL **INTERFERE** WITH EACH OTHER'S READINGS.

USE THE AUTOMATIC CHANNEL SELECTION TO FIND THE BEST CHANNEL FOR ELIMINATING ELECTROMAGNETIC INTERFERENCE (EMI).

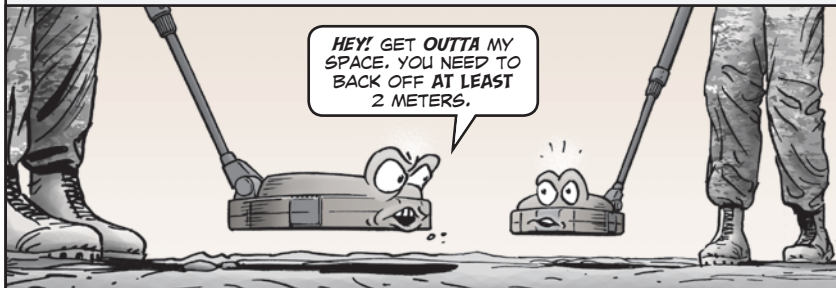

Keep the Detector Search Head Parallel to the Ground

THAT'S VERY IMPORTANT ON **UNEVEN GROUND**. IF THE HEAD IS AT AN ANGLE, IT CAN GIVE YOU FALSE GROUND PENETRATING RADAR (GPR) READINGS, WHICH COULD LEAD TO **DISASTER**.

TRY TO SWEEP ONE METER PER SECOND ACROSS A 1 1/2-METER LANE WITH THE HEAD NO MORE THAN TWO INCHES OFF THE GROUND.

Keep head parallel to ground and no more than 2 inches from ground

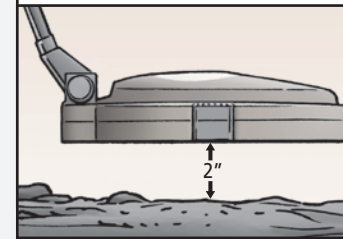

Remember **LOSS**:

L= Lane coverage
O= Operator stance
S= Sweep speed
S= Search head position

If Error Codes Won't Go Away, Turn Minehound Off and On

IF THAT **DON'T** GET RID OF THE ERROR CODES, CHANGE THE BATTERY.

STILL NO LUCK? TURN IN THE MINEHOUND. YOU'VE DONE ALL YOU CAN DO.

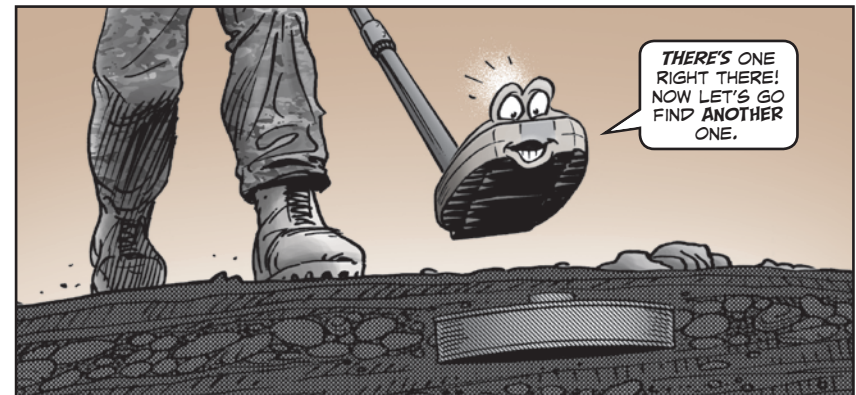
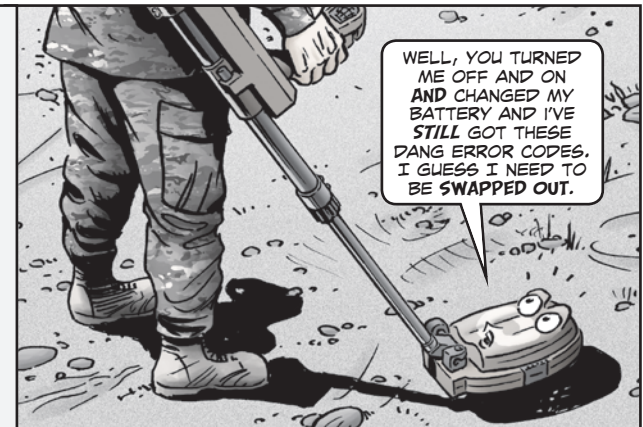

**WATCH
OUT!**

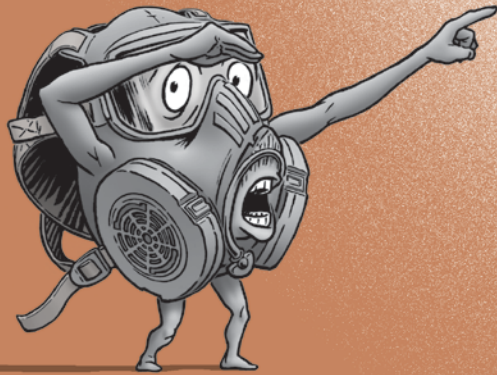

Dear Editor,
Here are a few things Soldiers need to watch out for when using and caring for their M50 masks:

Easy with the outsert. It's damaged more than any other item on the mask. Soldiers force it off, which breaks the outsert tabs and cracks the center of the outsert. The correct way is to grasp the top and bottom of the outsert with both hands and twist it up. It should come off easily. If it doesn't, don't force it. Tell your CBRN specialist.

Never go to the field without the outsert. If an outsert is damaged, it can be replaced for less than \$20. If the eye lenses are damaged, the facepiece assembly must be replaced.

CBRN specialists should keep extra outserts on hand. They'll need them.



Hold both sides of outsert and gently twist up

After cleaning the mask, check for the nosecup retaining ring. It often disappears and you don't notice until the nose cup falls out. If the retaining ring is missing, you must order a new facepiece assembly.

For storage of more than 30 days, install the faceform. That helps the mask keep its shape. The head harness straps just need to be snug for storage. If you over-tighten them, they lose their elasticity.

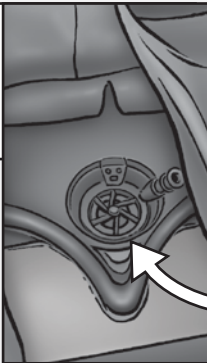

After cleaning, make sure nose cup retaining ring is still in place

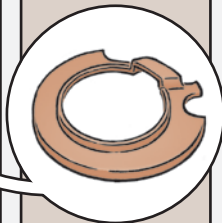

The M50, unlike the M40 mask, has a serial number. You can use the serial number to make accountability easier in accordance with your unit SOP.

SSG Christopher Butler
Ft Leonard Wood, MO

Editor's note: Excellent advice, Sergeant. Thanks.

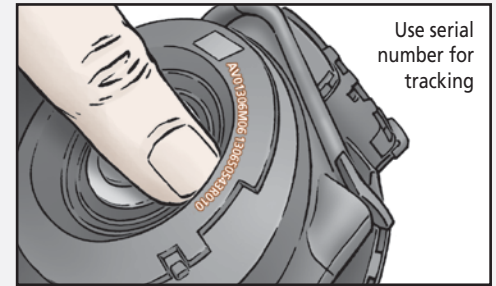

Use serial number for tracking

HIMARS...

CATCH CAB LATCH CRACKS!

I'VE GOT AN IMPORTANT CHECK FOR YOU TO ADD TO MY PMCS!

IT'S ABOUT MY CAB LATCH BRACKET.

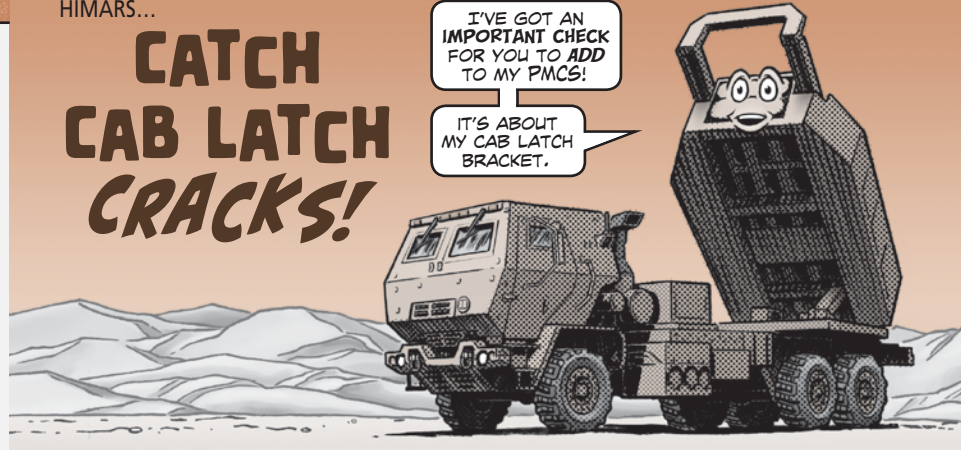

HIMARS units are finding vehicles with cracked rear cab support latches. That could be dangerous if the latch fails. The cab could pitch forward during a hard stop.

Before and after operations, crews need to check the support latch for cracks where the latch bracket is welded to the frame. Also look for any loose bolts securing the bracket to the frame.

Clean the area of any dirt before inspecting the support latch and its welds. Look closely. Dirt and CARC paint can make it difficult to see cracks.

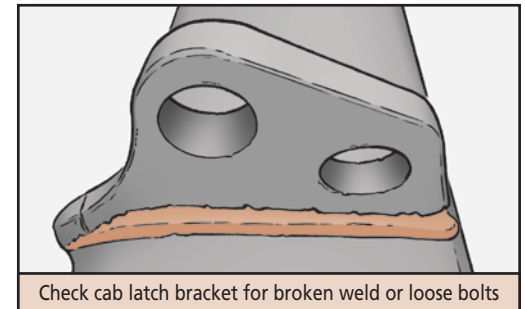

Check cab latch bracket for broken weld or loose bolts

Any cracks or loose latch bolts make the HIMARS NMC.

This cab latch bracket check will be added to Item 8 in TM 9-2320-450-10-2's PMCS.



- Help for Seeing in the Dark!
- Cable and Wire Handbook Drops
- MEP-804B Alternator MSN
- New TM for AN/PSQ-39
- Bigger Battery Better!
- AN/VVS-2 Parts Needed
- Keep Tabs on Electronic Equipment Tool Kit

HELP FOR SEEING IN THE DARK!



I REALLY CAN SEE BETTER IN THE DARK THANKS TO THESE TIPS FROM ERIC AND DANUAL.

GLAD WE COULD HELP, HALF-MAST.

Dear Editor,

Through our work maintaining AN/PVS-14 and AN/PVS-7B/D night vision devices at our Logistics Readiness Center (LRC), we offer these tips to help Soldiers see in the dark:

Don't remove the light interference filter (LIF). Some Soldiers think the LIF just gets in the way and they take it off. It's critical, though, to keep it screwed in. It protects the image intensifier from laser damage, but also protects the objective lens from scratches and cracks. If the LIF gets scratched up, it's not that expensive to replace. But replacing the image intensifier or objective assembly isn't just expensive, it's also time-consuming.

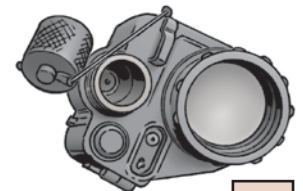

NVD



LIF

Check for the battery cap retainer. If the retainer is gone, the battery cap soon will be missing, too. Then your NVD is useless. Order a new retainer for the AN/PVS-14 or the AN/PVS-7-B/D with NSN 6160-01-448-6355.

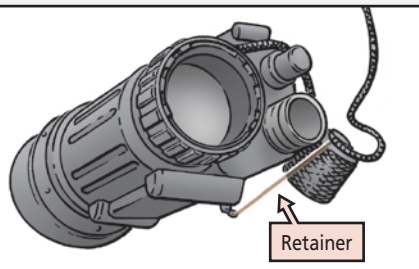

Pack with care. Soldiers often put the NVD in its storage bag and then stuff the mount on top of it. That usually results in a broken monocular housing, which lets the dry nitrogen leak out. The NVD fogs up and is difficult to see through. The gain control knob and power switch can also end up broken.

Soldiers should store the NVD in one compartment of the carrier and the mount in the other compartment. And don't toss the carrier down or pile stuff on it. Remember the carrier doesn't provide that much protection.

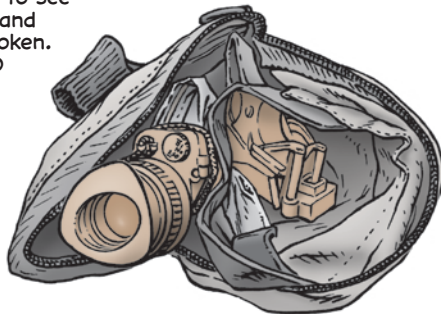

Store NVD and mount in separate compartments of carrier

Use lens paper, not your shirt, for cleaning. Rough material like your shirt scratches delicate and expensive lenses. Your NVD should've come with a package of lens paper in the carrier. If it's missing or used up, order NSN 6640-01-459-4239 for 50 sheets or get 100 sheets with NSN 6640-00-240-5851.

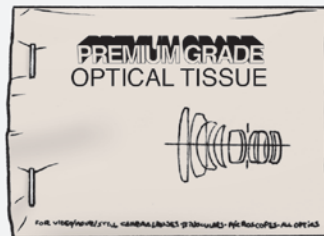

Some units are using a new cleaning device called a Lenspen.



One end is a brush...

...and the other is a cleaning tool.

Order it with NSN 1240-01-535-0972. It costs less than \$7.

As always, **REMOVE THE BATTERIES FOR STORAGE.** When we go to units, we usually find half the NVDs stored with their batteries installed. The batteries leak and soon corrosion has ruined the NVD. It takes just seconds to remove the batteries but saves thousands of dollars in the long run. Make battery removal part of the turn-in process.



WHILE I REALIZE IT'S IMPORTANT I GO IN THE ARMS ROOM, I DO *INSIST*, MY GOOD MAN, THAT YOU FIRST REMOVE MY BATTERY. IT'S A MATTER OF PRESERVATION, DON'T YOU SEE.

Eric Shove
Danual Smith
Ft Bragg, NC

Editor's note: We clearly see that these are great NVD tips. Thanks and thanks again.



Cable and Wire Handbook Drops

A new publication, Training Circular (TC) 6-02.20, *Cable and Wire Systems Handbook* (Jan 18), is available. The TC is a reference for personnel who install, maintain, test, troubleshoot, repair, fabricate, replace or recover wire and cable for Army communication networks. The pub covers installing and recovering wire and cable lines, pole climbing, splicing, wire ties, troubleshooting, wire line construction and wire records. Local area and wide area networks are also covered. To download, look for TC 6-02.20 at: <https://armypubs.army.mil/ProductMaps/PubForm/TC.aspx>

MEP-804B Alternator NSN

Get a direct current alternator for the engine used on the 15-kW, 50/60 Hz, MEP-804B generator with NSN 6115-01-382-3940 (PN 581200-33-0). It replaces NSN 6115-01-560-9146, which is shown as Item 8 in Fig 12 of TM 9-2815-254-24P (Jun 10). Please exhaust NSN 6115-01-560-9146 first because it's a terminal item.

New TM for AN/PSQ-39

TM 11-5855-344-10 (Mar 18), the operator's manual for the night vision AN/PSQ-39 viewer, NSN 5855-01-650-2680, has been released. Distribution is restricted, so you'll need to log in with your CAC to the Logistics Information Warehouse at:

<https://liw.logs.a.army.mil/>

Then choose the "ETM/IETM" icon and search for the TM by Pub Title Text, AN/PSQ-39.

Bigger Battery Better!

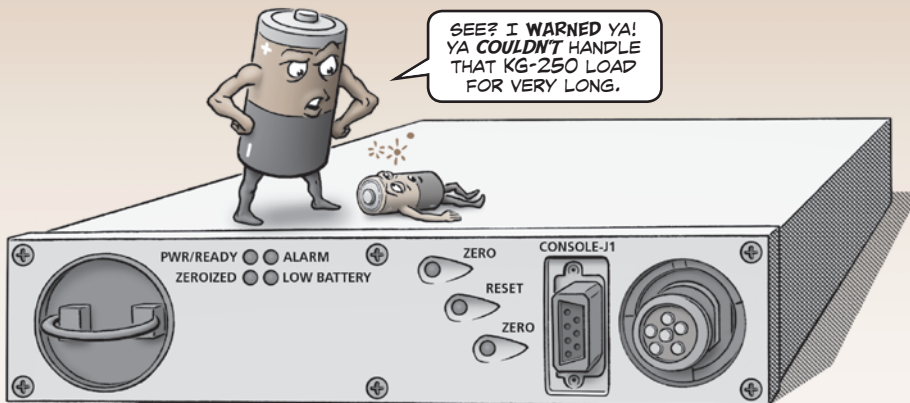

SEE? I WARNED YA!
YA *COULDN'T* HANDLE
THAT KG-250 LOAD
FOR VERY LONG.

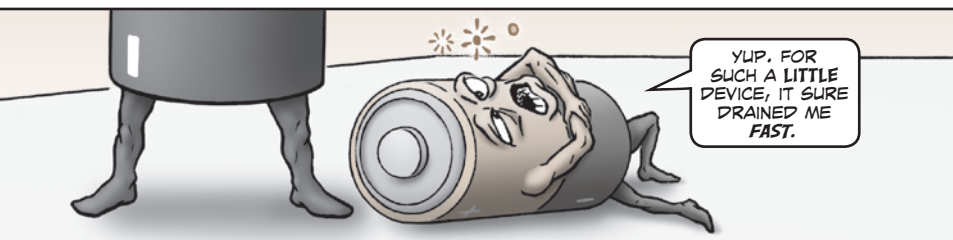

YUP. FOR
SUCH A LITTLE
DEVICE, IT SURE
DRAINED ME
FAST.

Dear Editor,

Too often in my work as a CECOM Sensor LAR, I see systems with problems because the KG-250 encryptor doesn't work. The majority of the time, it's due to a tamper issue, or else the "purple light of death."

Tamper issues are often resolved by resetting the encryptor with the appropriate tamper key. However, if inserting the correct tamper key doesn't work, then the device needs to be turned in through the Army's Information Systems Security Program (ISSP) process for repair.

The "purple light of death" means the internal battery has expired. In that case, the KG-250 must also go through the ISSP process. Once the internal battery is drained, the KG-250 needs sustainment-level repair.

The KG-250's internal battery should last three years if the device is properly maintained. There's a smaller 1/2 AA size battery and housing, but it only extends the internal battery for three months. There's a huge difference in the storage time.

Soldiers seem confused as to which battery should be used for long-term storage. Too often they let the KG-250's internal battery go dead because they aren't using the proper battery storage option.

Switching all KG-250 encryptors over to the longer-life C-cell battery and housing will eliminate a lot of internal battery failures in KG-250 encryptors Army-wide.

Soldiers can order the C-cell battery with NSN 6135-01-435-5558 and the C-cell battery housing with NSN 6160-01-575-7749. These will greatly increase the KG-250's lifespan.

ISSP Repair Process for CONUS

The ISSP process for KG-250 exchange has a few steps. One step involves the unit's property book officer, but it's not too complicated.

For instructions and assistance in replacing or repairing KG-250s, contact Anthony Black at ISSP, (520) 538-8005, or ISSP customer support at (520) 538-1829/8381, or email:

usarmy.huachuca.cecom.mbx.ilsc-csla-issp@mail.mil

Note: OCONUS users have different shipping requirements. Verify with ISSP before shipping to CONUS directly.

Gregory Janeczek
Ft Stewart, GA

THANKS FOR HELPING
KEEP THE DREADED
PURPLE LIGHT OF
DEATH AT BAY, GREG!



AN/VVS-2 Parts Needed

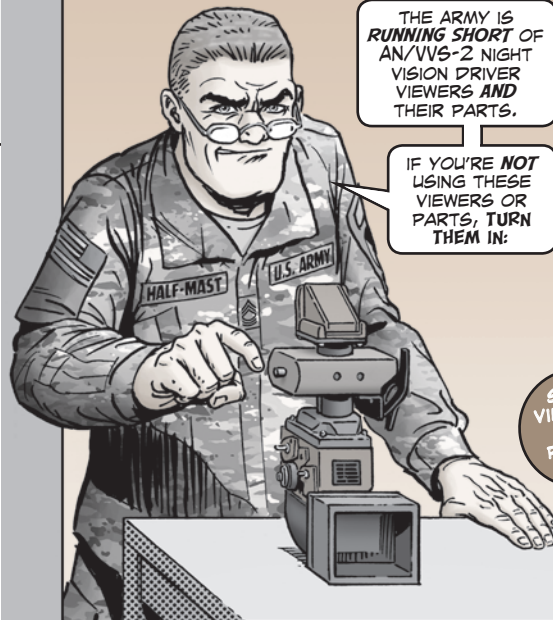

THE ARMY IS
RUNNING SHORT OF
AN/VVS-2 NIGHT
VISION DRIVER
VIEWERS **AND**
THEIR PARTS.

IF YOU'RE **NOT**
USING THESE
VIEWERS OR
PARTS, **TURN**
THEM IN:

SEND
VIEWERS
AND
PARTS
TO:

Nomenclature	NSN 5855-
AN/VVS-2(V)1A	01-096-0871
AN/VVS-2(V)2A	01-096-0872
AN/VVS-2(V)3	01-105-7793
AN/VVS-2(V)4	01-235-5489
Image intensifier	01-027-1554
Eye-piece assembly	01-027-3628
Housing assembly	01-047-9267
Housing section	01-412-4385
Eye-piece assembly	01-433-7009
Housing assembly	01-027-3639

W1A8 DLA Dist-Tobyhanna
Gibbs and 5th Streets
Warehouse 6, Bay 4
Tobyhanna PA 18466-5059
DODAAC W25G1W

QUESTIONS?

CONTACT SARAH KOVACS AT
(443) 396-1376 OR EMAIL:
sarah.kovacs.civ@mail.mil

KEEP TABS ON ELECTRONIC EQUIPMENT TOOL KIT

I DON'T EVEN KNOW *WHERE* TO START INVENTORY ON THIS TOOL KIT!

THAT'S *WHY* I'M HERE. THIS COMPONENT LIST WILL HELP SORT THINGS OUT.

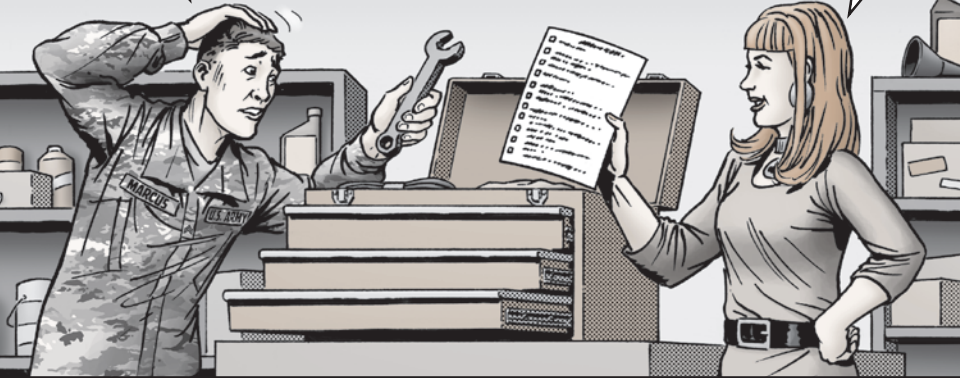

WHEN YOU INVENTORY YOUR TK-101/G TOOL KIT, NSN 5180-00-064-5178, LIN W37483, THERE ARE *LOTS* OF BITS N' BOBS TO SORT OUT.

USE THIS HANDY COMPONENT LIST TO CHECK THAT YOU'VE GOT IT *ALL*...

...AND IF *NOT*, ORDER WHAT YOU NEED TO KEEP THE KIT FULLY STOCKED!

Extension, socket wrench,
6 inches, 3/8-in drive,
NSN 5120-01-398-7673

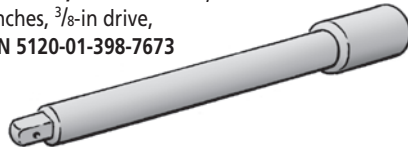

Extension, socket wrench,
3 inches, 3/8-in drive,
NSN 5120-01-358-2759

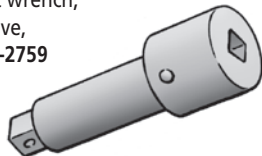

Handle, socket wrench,
3/8-in drive, 8-in long, hinged,
NSN 5120-00-240-5396



Handle, socket wrench,
ratchet, reversible,
NSN 5120-00-240-5364



Flashlight, hand, 2-cell, NSN 6230-00-163-1856

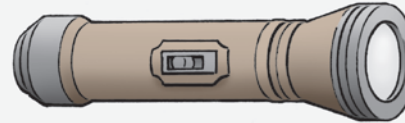

Flashlight, hand, 5 1/2-in, 2-cell, NSN 6230-01-259-4495

**Battery, nonrechargeable AA, (pkg of 2),
NSN 6135-01-165-0829**

**Brush, paint, squirrel tail, 1-in wide,
NSN 8020-00-245-4509**



**Key set,
socket head screw, hexagon,
NSN 5120-01-428-7913**

Key	NSN 5120-
2mm	01-428-8038
2.5mm	01-437-1648
3mm	01-428-8088
4mm	01-428-8095
5mm	01-428-8036
6mm	01-428-8106
7mm	01-428-8044
8mm	01-428-7967
9mm	01-428-7975
10mm	01-437-1645
12mm	01-428-8030

**Key set, socket head screw,
spline drive, L-type,
NSN 5120-00-087-6415**

Key, wrenching (size in inches)	NSN 5120-
.060	00-293-0195
.070	00-224-2496
.072	00-249-9670
.078	00-781-8977
.098	00-223-6995
.115	00-224-2482
.145	00-277-1724
.1875	00-198-5410

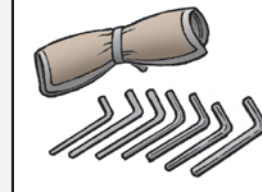

**Key set,
socket head screw,
hexagon,
NSN 5120-00-729-6392**

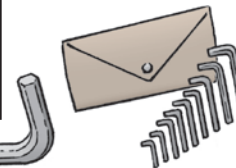

Key, wrenching (size in inches)	NSN 5120-
.035	00-198-5400
.050	00-198-5401
.0625	00-198-5398
.0781	00-224-2504
.0937	00-242-7410
.1250	00-240-5292
.1406	00-889-2163
.1562	00-198-5392
.1875	00-240-5300
.2187	00-242-7411
.250	00-224-4659



Nut driver, screwdriver type,
hexagonal wrenching set,
NSN 5120-00-542-5799, includes:



Mirror,
inspection, all angles,
NSN 5120-01-313-4097

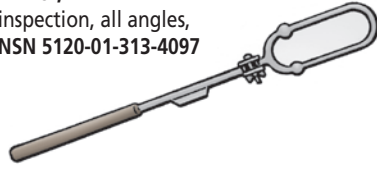

Knife,

pocket, electrician's, two blades,
NSN 5110-00-240-5943



Pliers, round nose,
short, without cutter, 6-in long,
NSN 5120-00-240-6172



Pliers, slip joint,
conduit type, 9-in long,
NSN 5120-00-624-8065

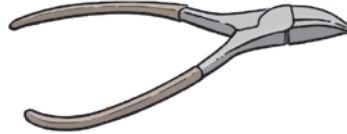

Pliers, slip joint,
regular, with cutter, 6-in long,
NSN 5120-00-223-7396

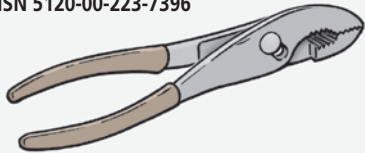

Screwdriver set,
jeweler's swivel knob,
NSN 5120-00-288-8739

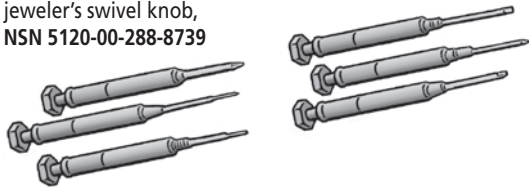

Screwdriver	NSN 5120-
.025-in tip	00-180-0705
.040-in tip	00-180-0706
.055-in tip	00-180-0727
.070-in tip	00-180-0728
.080-in tip	00-180-0729
.100-in tip	00-180-0730

Screwdriver, cross-tip, Phillips (size, length)	NSN 5120-	
	No. 2, 1 1/2 inches	00-227-7293
	No. 1, 3 inches	01-398-9248
	No. 2, 4 inches	01-398-9244
	No. 3, 6 inches	00-234-8912
No. 2, 8 inches	01-367-3801	

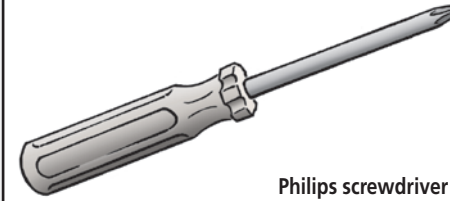

Phillips screwdriver

Screwdriver, flat tip	NSN 5120-	
	1/4-in tip, 1 1/2-in long	01-399-9144
	1/8-in tip, 2-in long	01-429-6451
	1/4-in tip, 4-in long	01-406-7728
	3/16-in tip, 5-in long	01-487-3824
9/64-in tip, 8-in long	00-278-1267	

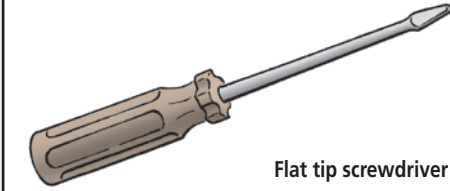

Flat tip screwdriver

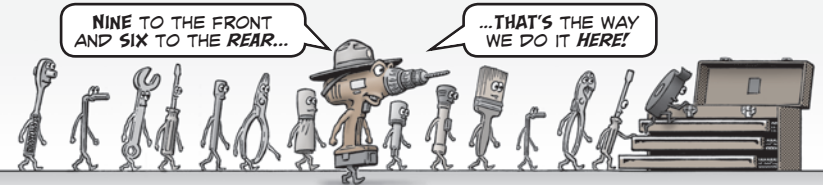

Screwdriver, ratchet, flat tip,
1/4-in short end and 3/8-in long end,
NSN 5120-00-595-9574

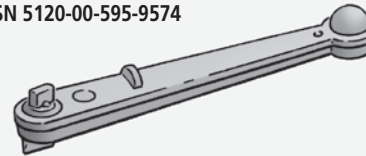

Screwdriver,
offset, ratchet, crosspoint,
NSN 5120-00-892-5931

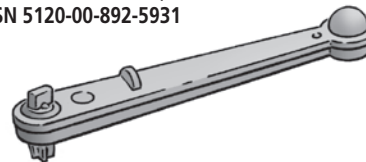

Socket, socket wrench set, NSN 5120-01-429-3585, includes:	NSN 5120-
8mm	01-348-9129
9mm	01-348-9130
10mm	01-348-9131
11mm	01-348-9132
12mm	01-348-9133
13mm	01-348-9134
14mm	01-348-9135
15mm	01-348-9136
16mm	01-348-9137
17mm	01-348-9243
18mm	01-348-9244
19mm	01-348-9245

- **Plier wrench,** 7-in long, adjustable with wire cutter, NSN 5120-00-494-1910
- **Pliers, plain,** 4-in long, with cushion grip handles, NSN 5110-00-764-4801

Socket, socket wrench set, NSN 5120-01-429-3603, includes:	NSN 5120-
1/4	01-350-1002
5/16	01-350-1003
11/32	01-350-1004
3/8	01-350-1005
7/16	01-350-1006
1/2	01-350-1007
9/16	01-350-0989
5/8	01-350-0990
11/16	01-350-0991
3/4	01-350-0992
13/16	01-350-0993
7/8	01-350-0988

Hand pliers,
wire stripper, 26 and 28 AWG
stranded, yellow handles,
NSN 5110-01-019-1772

Universal joint,
socket wrench
attachment,
3/8-in drive,
NSN 5120-00-224-9215

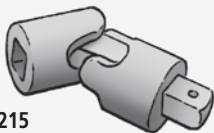

Wrench, open end, adjustable	NSN 5120-
6-in long	01-335-2216
8-in long	01-335-2217

Wrench, open end, adjustable



Tool,
load-tightening,
NSN 5120-01-172-8079

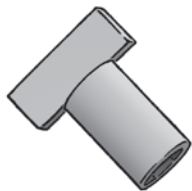

Tape,
insulation, electrical,
black, 0.75 inch wide,
36 yards,
NSN 5970-00-419-4291

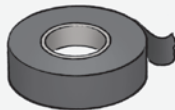

Tool box,
NSN 5140-01-534-3681

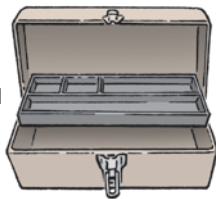

Wrench set,
spanner,
NSN 5120-00-658-9805



Wrench, box/open end, combo	NSN 5120-
3/8 inch	01-398-9294
7/16 inch	01-398-9295
1/2 inch	01-398-9221
9/16 inch	01-398-9222

Wrench, box/open end, combo

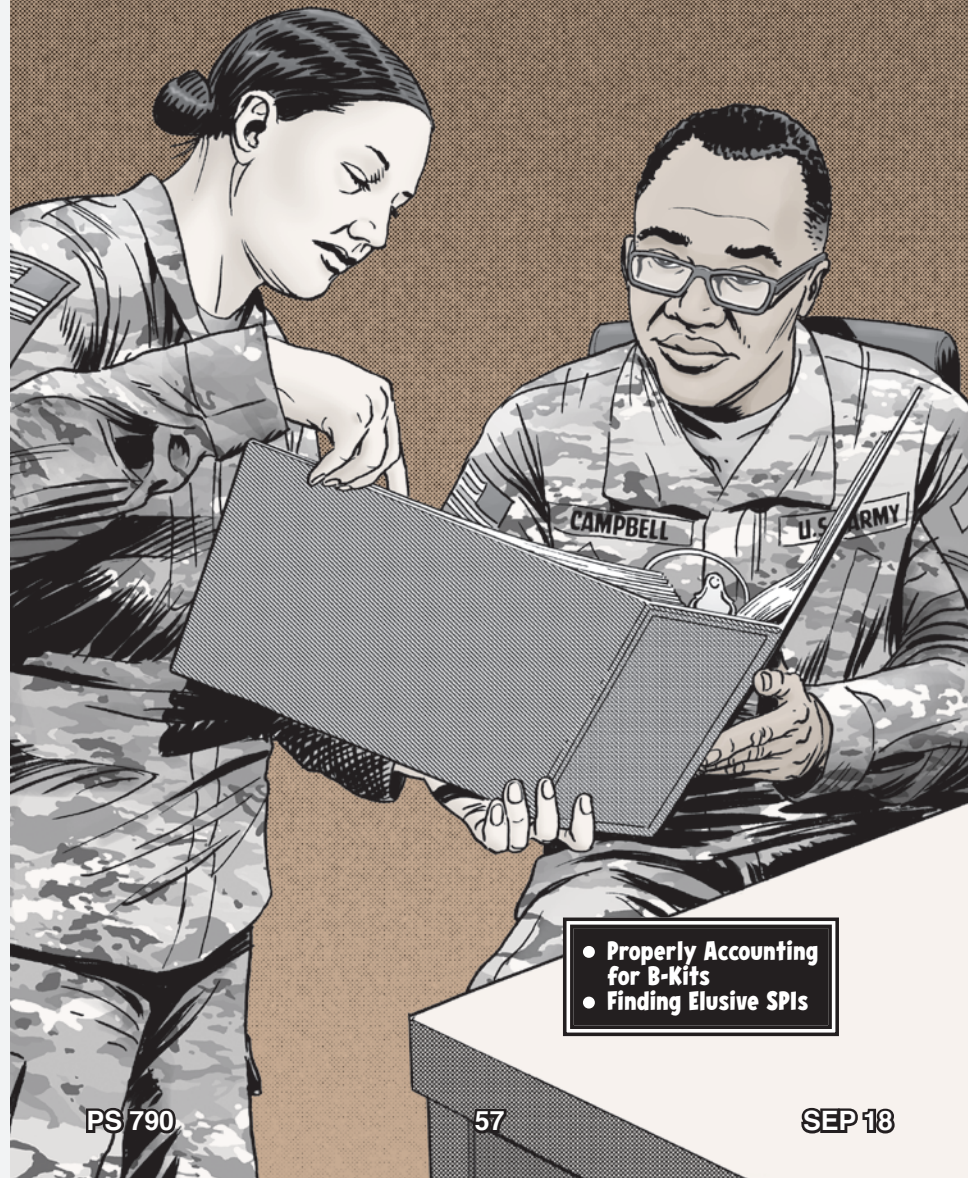
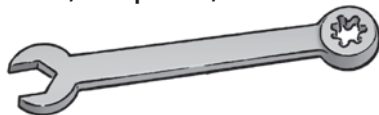

- Properly Accounting for B-Kits
- Finding Elusive SPIs

HMMM. WONDER WHY OUR READINESS RATINGS TOOK A HIT?

DID YA FORGET THAT THIS CLASSY ARMOR NEEDS TO BE REPORTED SEPARATELY IN THE PROPERTY BOOK?

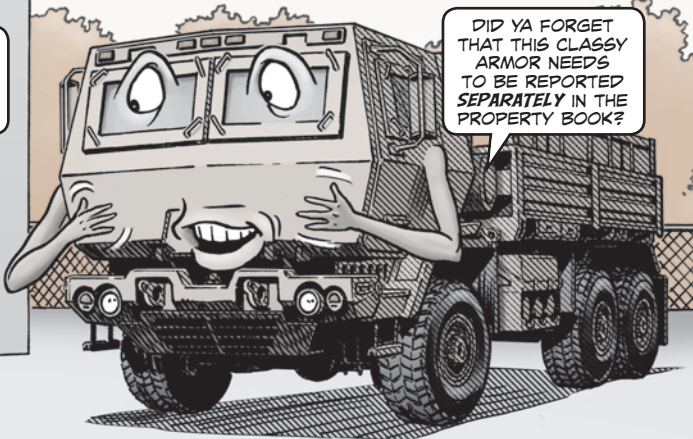

Properly Accounting for B-Kits

BOLT-ON ARMOR KITS (B-KITS) GIVE A WELCOME ADDITIONAL LAYER OF PROTECTION TO HEAVY AND MEDIUM TACTICAL VEHICLES.

BUT FOR PROPERTY ACCOUNTABILITY PURPOSES, B-KITS ARE CONSIDERED SEPARATE COMPONENTS FROM THE VEHICLES.

THIS MEANS THAT B-KITS MUST BE ACCOUNTED FOR SEPARATELY IN GLOBAL COMBAT SUPPORT SYSTEM-ARMY (GCSS-ARMY).

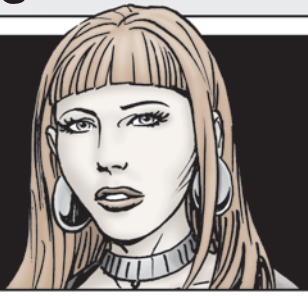

WHY DOES IT MATTER?

WELL, PROPER ACCOUNTING OR CORRECTING ISSUES AT THE PROPERTY BOOK LEVEL CAN BOOST A UNIT'S OVERALL READINESS RATINGS.

AND THAT'S A GOOD THING!



THERE ARE 3 B-KIT VARIANTS:

1. Heavy Expanded Mobility Tactical Truck (HEMTT) B-kit, NSN 2450-01-552-6333, LIN A91875 (installed on certain HEMTT tactical truck models);
2. Family of Medium Tactical Vehicles (FMTV) B-kit with 58-gal fuel tank fire suppression (FTFS) kit, NSN 2540-01-552-7805, LIN A37814 (installed on certain FMTV tactical truck models); and
3. FMTV B-kit with 78-gal FTFS kit, NSN 2540-01-576-3447, LIN A38064 (installed on certain FMTV tactical truck models).

THE FOLLOWING TABLE LISTS THE B-KIT VARIANTS AND THE VEHICLES THEY BELONG TO...



Heavy Tactical Vehicles

HEMTT B-kit, NSN 2450-01-552-6333, LIN A91875, may be installed on the following HEMTT tactical truck models:

Model	NSN 2320-	LIN
M977A4	01-534-1091	T59532
M978A4	01-534-1117	T58318
M983A4	01-534-2228	T88915
M983A4 LET	01-534-2229	T60946
M984A4	01-534-2245	T63161
M985A4	01-534-1877	T59380
M985A4 GMT	01-534-1887	T59652
M1120A4	01-534-1872	T55054

Medium and Light Medium Tactical Vehicles

FMTV B-kit with 58-gal FTFS kit, NSN 2540-01-552-7805, LIN A37814, installed on the following FMTV tactical truck models:

Model	NSN 2320-	LIN
M1078A1P2 W/W	01-549-8611	T42131
M1078A1P2 WO/W	01-549-8577	T59448
M1079A1P2 W/W	01-552-7749	T62623
M1079A1P2 WO/W	01-552-7745	T62359
M1083A1P2 W/W	01-549-8565	T41447
M1083A1P2 WO/W	01-549-8610	T41515

FMTV B-kit with 78-gal FTFS kit, NSN 2540-01-576-3447, LIN A38064, installed on the following FMTV tactical truck models:

Model	NSN 2320-	LIN
M1084A1P2 W/MHE WO/W	01-552-7739	T59584
M1084A1P2/RSV	01-552-7739	T59584
M1085A1P2 W/W	01-552-7770	T93339
M1085A1P2 WO/W	01-552-7773	T93271
M1086A1P2 W/W	01-552-7776	T62180
M1086A1P2 WO/W	01-552-7780	T62112
M1087A1P2 WO/W	01-552-7781	T67136
M1088A1P2 W/W	01-552-7753	T61375
M1088A1P2 WO/W	01-552-7759	T88983
M1089A1P2	01-552-7762	T94671
M1148A1P2	01-557-4546	T54516
M1157A1P2 W/W	01-552-7782	T65274
M1157A1P2 WO/W	01-552-7787	T65342

REMEMBER TO MAKE SURE ANY B-KITS ARE RECORDED CORRECTLY ON THE PROPERTY BOOK.

THEN YOU'LL BE PROTECTED IN YOUR TRUCKS AND ON THE BOOKS.



Finding Elusive SPIs

TO GET THE SPI FOR YOUR ITEM, USE YOUR CAC AND GO TO THE ARMY ENTERPRISE SYSTEMS INTEGRATION PROGRAM (AESIP).



IF YOU'RE STILL HAVING TROUBLE FINDING THE SPI, SEND AN EMAIL TO LOGSA PSCC.



Dear Half-Mast,

I looked up the Army packaging instructions for a specific item in our warehouse and it has a Special Packaging Instruction (SPI) number. Who do I contact to get the SPI?

SPC C.H.

Dear Specialist,

To get the SPI for your item, use your CAC and go to the Army Enterprise Systems Integration Program (AESIP): <https://www.aesip.army.mil/irj/portal>. Once you're logged in, click on SPI/PDS Maintenance. Open the Choose Action dropdown menu and select SPI-SEARCH. Enter the NIIN in the Material block and click Search. If the SPI you're looking for is listed, click View SPI. If the packaging data isn't listed in AESIP, search the Federal Logistics System (FED LOG) instead. Once in FED LOG, select Search Interactive, then click the Army Interactive Query tab. Enter the item's NIIN in the NIIN field, select Search and click on the Army Packaging tab to find the SPI.

If the item is a TACOM item and you have a CAC, you can also try to search for the SPI here: <https://www.ilsc.army.mil/packaging>

If you're still having trouble finding the SPI, send an email to LOGSA PSCC:

usarmy.tyad.usamc.mbx.pt@mail.mil

Half-Mast

Connie's
POST PS
SCRIPTS

GCSS-Army URL Change

On Page 59 of PS 786 (May 18) we encouraged readers to sign up for automatic notifications from GCSS-Army. The information is still available, but the URL has changed. To sign up for GCSS-Army notifications go to: <https://gcss.army.mil/Registration/Registration>

EMS Monthly Newsletter

The Electronic Maintenance Software (EMS) team publishes a monthly newsletter featuring EMS tips, important information about future releases and other EMS-related updates.

To subscribe, send an email to:

usarmy.detroit.tacom.mbx.ilsc-electronic-maintenance-system@mail.mil

DESICCANTS DO THE JOB

Order a drum of 300 desiccant bags with NSN 6850-00-264-6571. Tuck bags in moisture-prone spots to keep equipment corrosion at bay. Be sure to place 'em where they won't block vents, fall into moving parts or otherwise jack up your equipment. Replace desiccants as needed or during scheduled services.

HMMWV A/C Louvers NSN Correction

The HMMWV "Toss and Go" story on Page 13 of PS 786 (May 18) contained two transposed numbers in the A/C louvers NSN. The correct NSN is 2540-01-536-3029. Thanks to the alert reader who spotted this typo!

M149A2, M112 WATER TRAILER TANK HEATER

Get a new Active Gear Co. diesel heater kit for the water tanks on your M149A2 and M112 trailers with NSN 2990-20-005-7263. This heater kit replaces the old M67 immersion heater, comes mostly assembled and is easy for field maintenance to install. The heater mounts to the trailer's drawbar, and comes with the manufacturer's operator and maintenance manual. It's currently on back order, but delivery is expected by Oct 18. So get your orders in now before the weather turns cold.

LIGHT TRAILER WHEEL ASSEMBLIES REVISITED

Page 13 of PS 766 (Sep 16) listed the wrong tire and wheel assembly for the M103A3, M105A2, M149, M149A1, and M332 trailers. The correct NSN for those trailers is **2530-01-611-7619**.

Only the M105A3 and M200A1 trailers use wheel assembly, NSN 2530-01-528-9461, that's listed in the chart. Make a note until a new chart is published.

Would You Stake Your Life ^{right now} on the Condition of Your Equipment?

Not sure how long annual services should take?

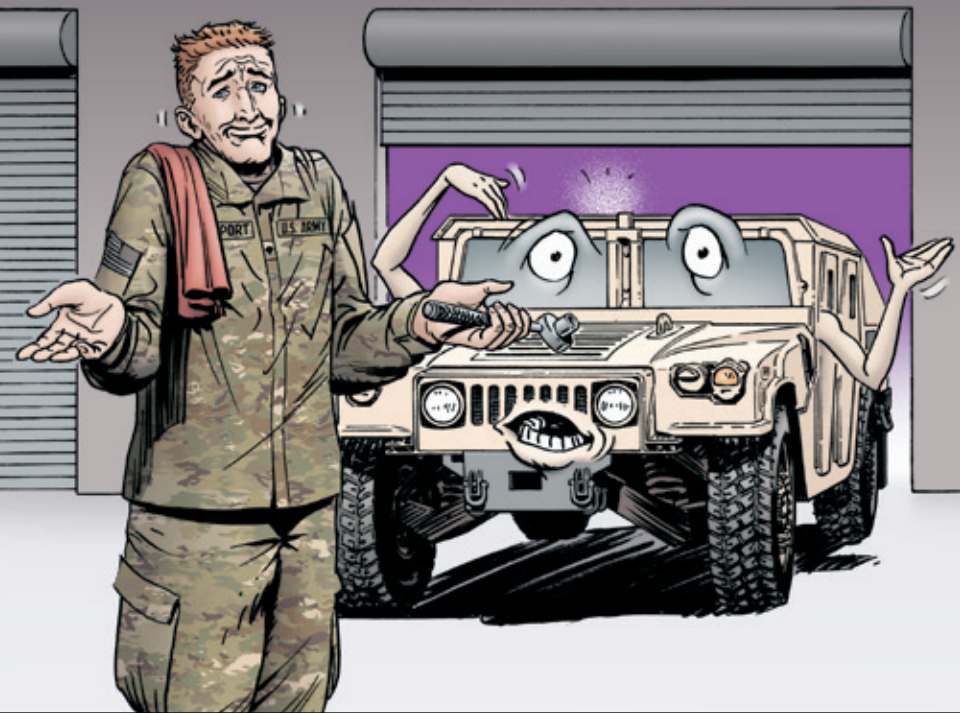

Check the maintenance allocation chart (MAC) in your equipment's TM.